

# TSM23S/Q

## Integrated Step-Servo Motor



Hardware Manual

Rev. 1.0

AMP & MOONS' Automation

## Contents

1	Introduction .....	4
1.1	Features .....	4
1.2	Block Diagram .....	5
1.3	Safety Instructions .....	6
2	Getting Started .....	7
2.1	Installing Software .....	7
2.2	Mounting the Hardware .....	7
2.3	Choosing a Power Supply .....	8
2.3.1	Voltage .....	8
2.3.2	Regeneration Clamp .....	8
2.3.3	Current .....	9
3	Installation/Connections .....	12
3.1	Connecting the Power Supply .....	12
3.2	Connecting the TSM23S/Q Communications .....	13
3.2.1	Connecting to the PC using RS-232 .....	13
3.2.2	Connecting to a Host using RS-485 .....	14
3.3	Inputs and Outputs .....	16
3.3.1	Connector Pin Diagram .....	16
3.3.2	STEP & DIR Digital Inputs .....	17
3.3.3	X3/X4/X5/X6 Digital Input .....	18
3.3.4	X7/X8 Digital Input .....	19
3.3.5	AIN Input .....	19
3.3.6	Programmable Output Y1/Y2/Y3 .....	20
3.3.7	Programmable Output Y4 .....	21
4	Troubleshooting .....	22
5	Reference Materials .....	23

5.1 Torque-Speed Curves .....	23
5.2 Mechanical Outlines .....	24
5.3 Technical Specifications.....	25
5.4 SCL Command Reference .....	26
6 Contacting MOONS' .....	28

Model	Communications	
	RS-232	RS-485
TSM23S-2AG	✓	
TSM23S-2RG		✓
TSM23S-3AG	✓	
TSM23S-3RG		✓
TSM23Q-2AG	✓	
TSM23Q-2RG		✓
TSM23Q-3AG	✓	
TSM23Q-3RG		✓

## 1 Introduction

Thank you for selecting the MOONS' TSM23S/Q Integrated Motor. The TSM line of integrated step-servo motors combines servo technology with an integrated motor to create a product with exceptional feature and broad capability. We hope our commitment to performance, quality and economy will result in a successful motion control project.



### 1.1 Features

- Programmable, Digital servo driver and motor in an integrated package
- Operates from a 12 to 70 volt DC power supply
- Control Modes:
  - Torque Control
    - \* Analog input
    - \* SCL commanded
  - Velocity Control
    - \* Digital input Control Velocity
    - \* Analog velocity
    - \* SCL Commanded Velocity (Jogging)
  - Position Control
    - \* Digital Signal type
      - Step & Direction
      - CW & CCW pulse
      - A/B Quadrature
    - \* Analog Position
    - \* Serial Commanded Position
  - Q Programming(Q Version only)
    - \* Stand alone operation
- Communications:
  - RS-232 or RS-485
- 5000 line (20,000 counts/rev) encoder feedback
- Available torque:
  - TSM23□-2□G: Up to 1.0 N•m Continuous(1.3 N•m Boost)
  - TSM23□-3□G: Up to 1.5N•m Continuous(2.0 N•m Boost)
- I/O:
  - 8 optically isolated digital inputs, with adjustable bandwidth digital noise rejection filter, 5 to 24 volts
  - 4 optically isolated digital output, 30V/100 mA max.
  - 1 analog input for speed and position control, 0 to 5 volts
  - Differential encoder outputs (A±, B±, Z±), 26C31 line driver, 20 mA sink or source max
- Technological advances:
  - Full servo control, Closed loop
  - Efficient, Accurate, Fast, Smooth
  - Intelligent, Compact

## 1.2 Block Diagram

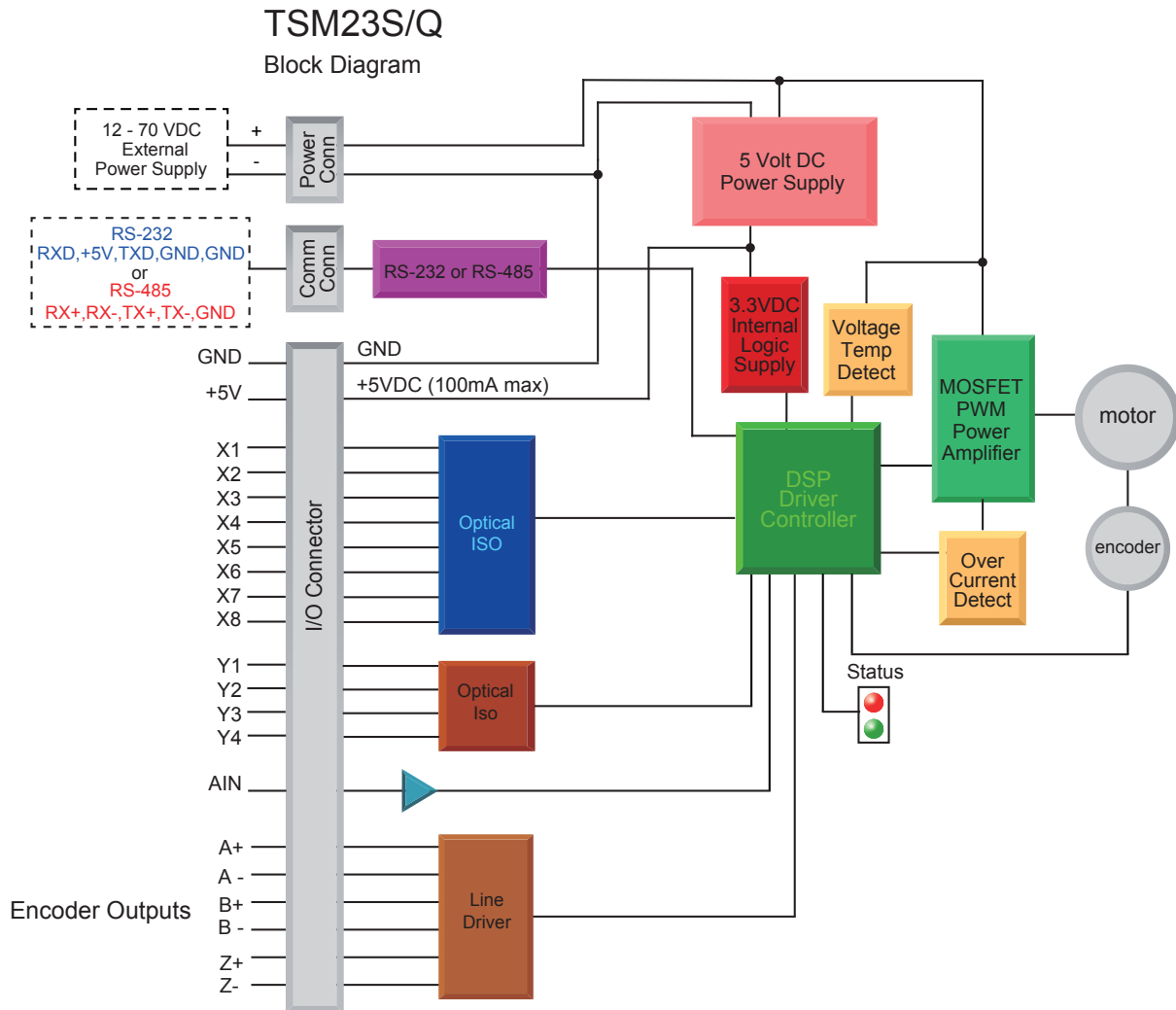

### 1.3 Safety Instructions

Only qualified personnel should transport, assemble, install, operate, or maintain this equipment. Properly qualified personnel are persons who are familiar with the transport, assembly, installation, operation, and maintenance of motors, and who meet the appropriate qualifications for their jobs.

To minimize the risk of potential safety problems, all applicable local and national codes regulating the installation and operation of equipment should be followed. These codes may vary from area to area and it is the responsibility of the operating personnel to determine which codes should be followed, and to verify that the equipment, installation, and operation are in compliance with the latest revision of these codes.

Equipment damage or serious injury to personnel can result from the failure to follow all applicable codes and standards. MOONS' does not guarantee the products described in this publication are suitable for a particular application, nor do they assume any responsibility for product design, installation, or operation.

- Read all available documentation before assembly and operation. Incorrect handling of the products referenced in this manual can result in injury and damage to persons and machinery. All technical information concerning the installation requirements must be strictly adhered to.
- It is vital to ensure that all system components are connected to earth ground. Electrical safety is impossible without a low-resistance earth connection.
- This product contains electrostatically sensitive components that can be damaged by incorrect handling. Follow qualified anti-static procedures before touching the product.
- During operation keep all covers and cabinet doors shut to avoid any hazards that could possibly cause severe damage to the product or personal health.
- During operation, the product may have components that are live or have hot surfaces.
- Never plug in or unplug the Integrated Motor while the system is live. The possibility of electric arcing can cause damage.

Be alert to the potential for personal injury. Follow recommended precautions and safe operating practices emphasized with alert symbols. Safety notices in this manual provide important information. Read and be familiar with these instructions before attempting installation, operation, or maintenance. The purpose of this section is to alert users to the possible safety hazards associated with this equipment and the precautions necessary to reduce the risk of personal injury and damage to equipment. Failure to observe these precautions could result in serious bodily injury, damage to the equipment, or operational difficulty.

## 2 Getting Started

The following items are needed:

- a 12 - 70 Volt DC power supply, see the section below entitled “Choosing a Power Supply” for help in choosing the right one
- a small flat blade screwdriver for tightening the connectors (included)
- a PC running Microsoft Windows 2000, XP, Vista, or Windows 7
- a MOONS' programming cable (included with RS-232 Models; RS-485 converters are available from MOONS')

### 2.1 Installing Software

Before utilizing the TSM23S/Q Integrated Step-Servo Motor and Step-Servo Quick Tuner Software in an application, the following steps are necessary:

- Install the Step-Servo Quick Tuner software from the MOONS' website.
- Connect the drive to the PC using the programming cable. When using RS-485, it must be setup in a 4-Wire configuration (see “Connecting to a host using RS-485” below.)
- Connect the drive to the power supply. See instructions below.
- Launch the software by clicking Start...Programs...MOONS'.
- Apply power to the drive.
- The software will recognize the drive and display the model and firmware version. At this point, it is ready for use.

### 2.2 Mounting the Hardware

As with any step motor, the TSM23S/Q must be mounted so as to provide maximum heat sinking and airflow. Keep enough space around the Integrated Motor to allow for airflow.



- Never use the drive where there is no airflow or where other devices cause the surrounding air to be more than 40°C (104°F).
- Never put the drive where it can get wet.
- Never use the drive where metal or other electrically conductive particles can infiltrate the drive.
- Always provide airflow around the drive.

## 2.3 Choosing a Power Supply

The main considerations when choosing a power supply are the voltage and current requirements for the application.

### 2.3.1 Voltage

The TSM23S/Q is designed to give optimum performance between 24 and 48 Volts DC. Choosing the voltage depends on the performance needed and motor/drive heating that is acceptable and/or does not cause a drive over-temperature. Higher voltages will give higher speed performance but will cause the TSM23S/Q to produce higher temperatures. Using power supplies with voltage outputs that are near the drive maximum may significantly reduce the operational duty-cycle.

The extended range of operation can be as low as 10 VDC minimum to as high as 75 VDC maximum. When operating below 18 VDC, the power supply input may require larger capacitance to prevent under-voltage and internal-supply alarms. Current spikes may make supply readings erratic. The supply input cannot go below 10 VDC for reliable operation. Absolute minimum power supply input is 10 VDC. If the Input supply drops below 10 VDC the low voltage alarm will be triggered. This will not fault the drive.

Absolute maximum power supply input is 75 VDC at which point an over-voltage alarm and fault will occur. When using a power supply that is regulated and is near the drive maximum voltage of 75 VDC, a voltage clamp may be required to prevent over-voltage when regeneration occurs. When using an unregulated power supply, make sure the no-load voltage of the supply does not exceed the drive's maximum input voltage of 75 VDC.

### 2.3.2 Regeneration Clamp

If a regulated power supply is being used, there may be a problem with regeneration. When a load decelerates rapidly from a high speed, some of the kinetic energy of the load is transferred back to the power supply, possibly tripping the over-voltage protection of a regulated power supply, causing it to shut down. This problem can be solved with the use of a MOONS' RC880 Regeneration Clamp. It is recommended that an RC880 initially be installed in an application. If the "regen" LED on the RC880 never flashes, the clamp is not necessary.

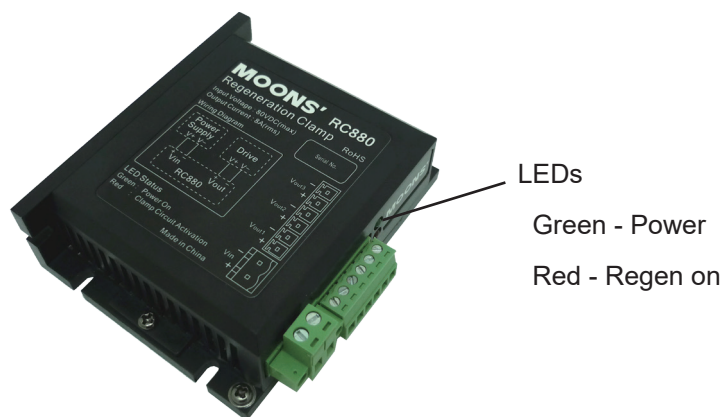

RC880 Regen Clamp

### 2.3.3 Current

The maximum supply currents required by the TSM23S/Q are shown in the charts below at different power supply voltage inputs. The TSM23S/Q power supply current is lower than the winding currents because it uses switching amplifiers to convert a high voltage and low current into lower voltage and higher current. The more the power supply voltage exceeds the motor voltage, the less current will be required from the power supply.

It is important to note that the current draw is significantly different at higher speeds depending on the torque load to the motor. Estimating how much current is necessary may require a good analysis of the load the motor will encounter.

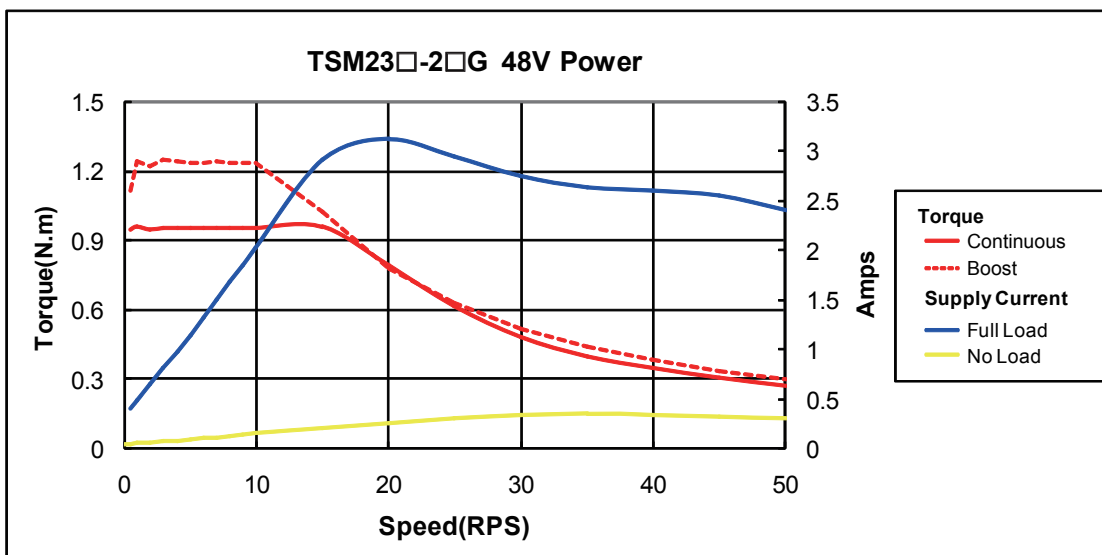
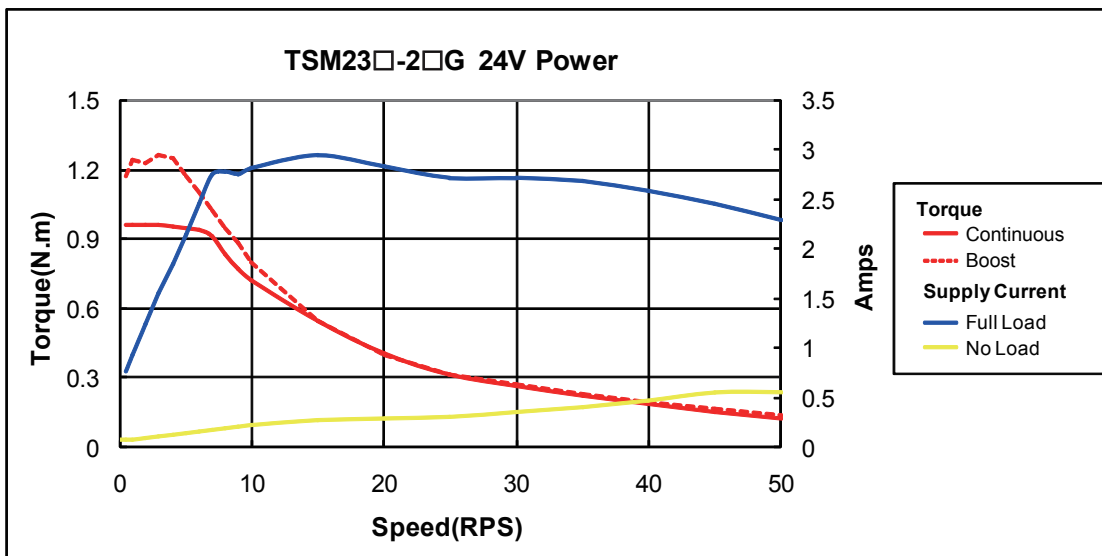

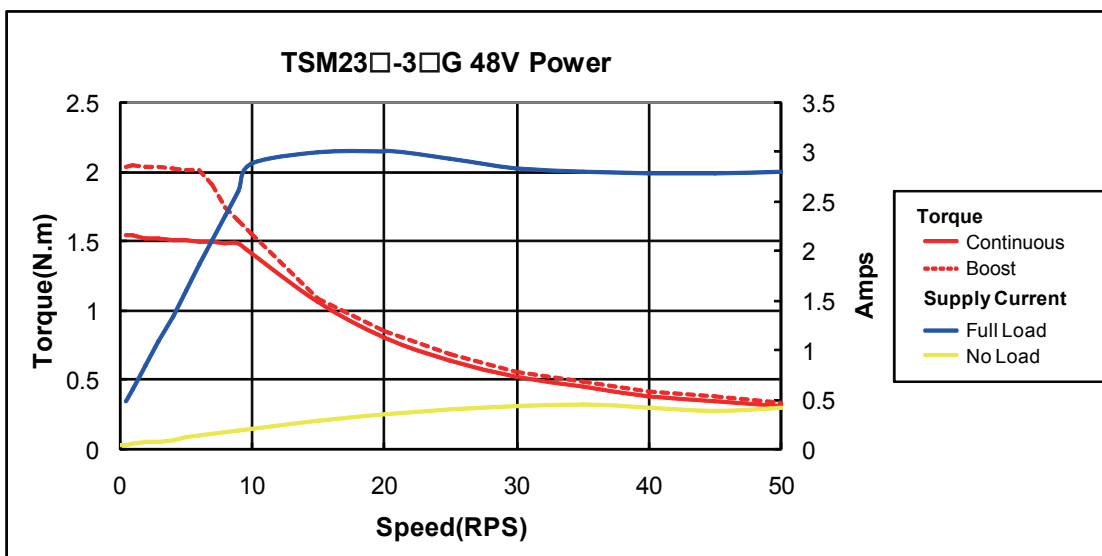
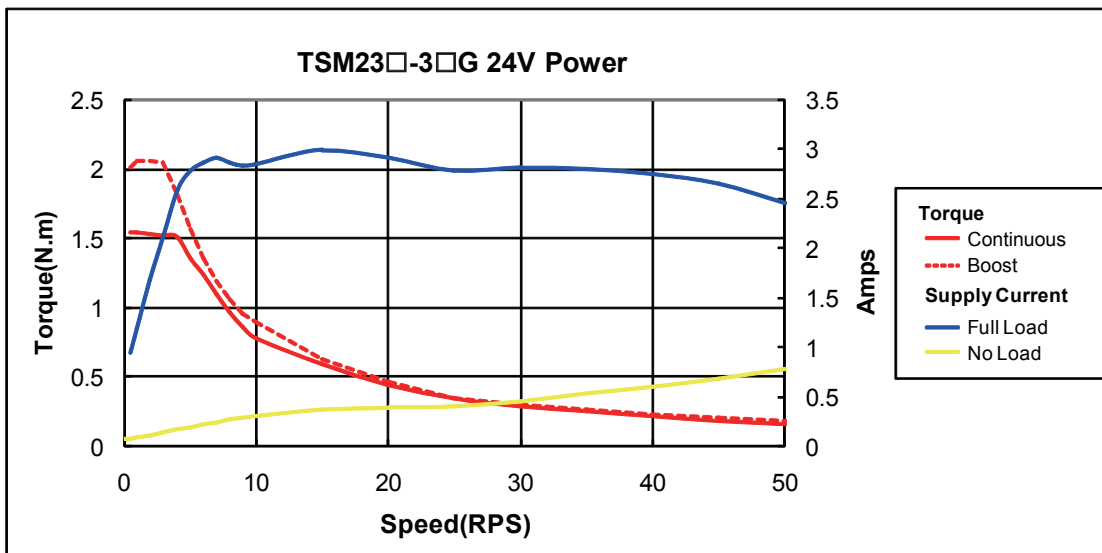
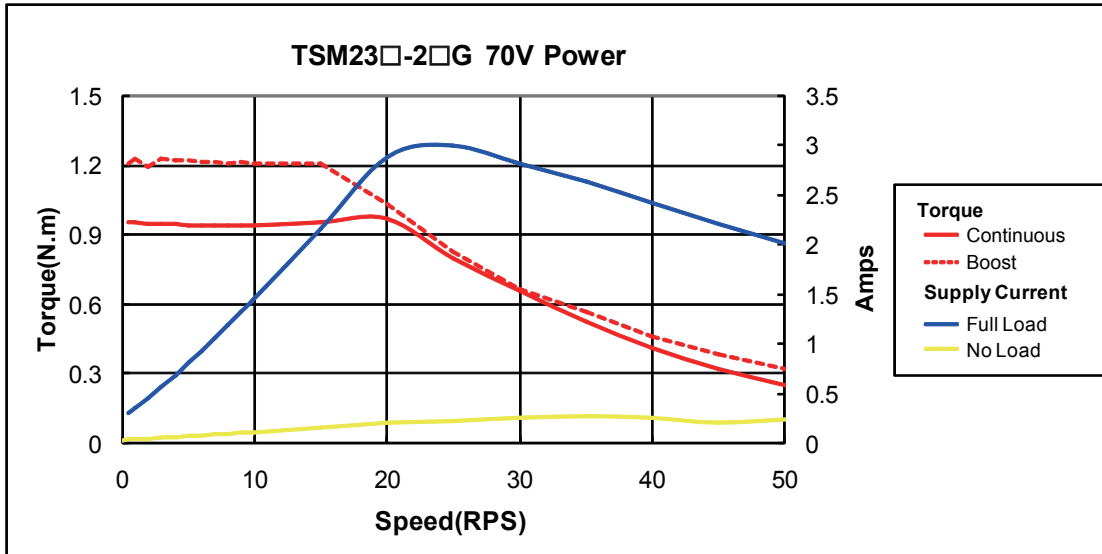

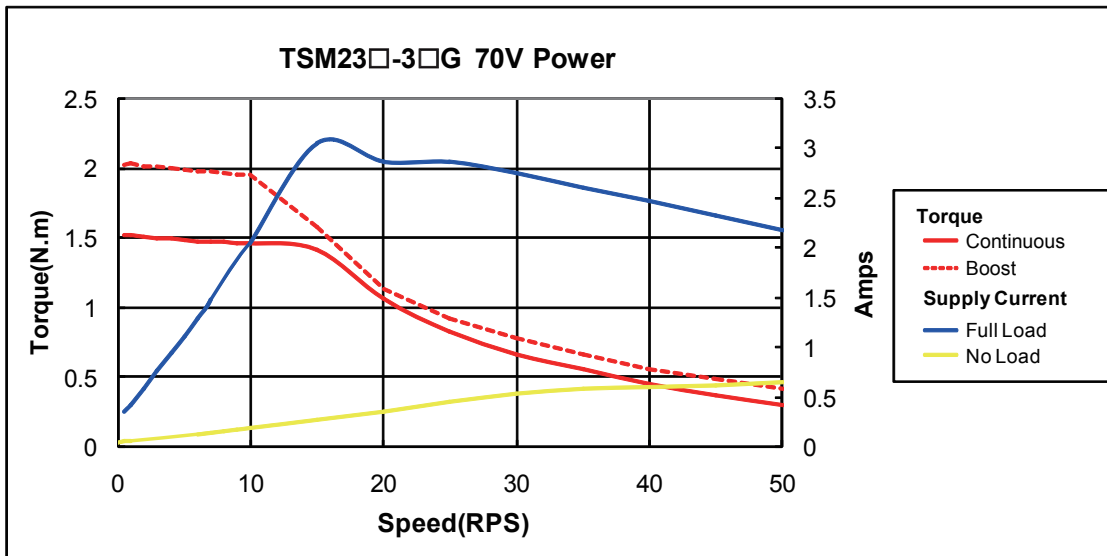

### 3 Installation/Connections

#### 3.1 Connecting the Power Supply

Use 16 to 20-gauge wire to connect the TSM23 to a power supply. It contains an internal fuse connected to the “+” terminal that is not user replaceable. If a user serviceable fuse is desired, install a 6.3 amp fast acting fuse in line with the “+” power supply lead.



**Be careful not to reverse the wires. Reversing the connection may open the internal fuse on the drive and void the warranty.**

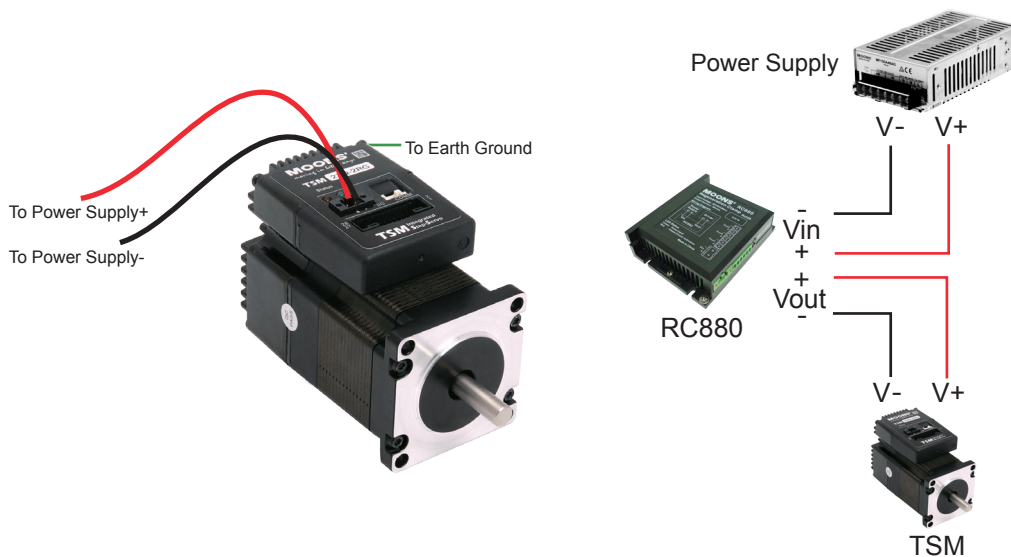

MOONS' offers two matched power supplies for use with the TSM23S/Q. A 24VDC, 150W(P/N MF150A24AG-V) and a 48VDC 320W(P/N MF320A48AG-V). These power supplies have current over load capability making them ideal for use. (To use with a switch power supplier, a RC880 regen must be connected in system)

The RC880 regeneration clamp is for use where regeneration from the motor may cause damage to the drive. In these cases the RC880 is connected between the drive and power supply and absorbs regenerated energy.

## 3.2 Connecting the TSM23S/Q Communications

The TSM23S/Q is available with two types of serial communications, RS-232 (TSM23S/Q -□AG) or RS-485 (TSM23S/Q -□RG). Each type requires a different hardware connection for interface to a PC or other Host system. The RS-232 version comes with a cable that will provide the interface to an RS-232 port through a DB9 style connector. The RS-485 version requires the user to provide both the cabling and the RS-485 interface. Below are descriptions of how to interface both of these serial communication types to a PC.

### 3.2.1 Connecting to the PC using RS-232

Locate the TSM23S/Q within 1.5 meters of the PC. Plug the DB9 connector of the communication cable that came with the drive into the serial port of the PC. Plug the small end into the crimp style connector on the TSM23S/Q. Secure the cable to the PC with the screws on the DB9 connector.

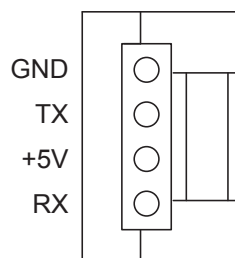

**Note: If the PC does not have an RS-232 serial port, a USB Serial Converter will be needed. You can contact MOONS' to buy a USB to RS-232 converter.**

The RS-232 circuitry does not have any extra electrical “hardening” and care should be taken when connecting to the RS-232 port as hot plugging could result in circuit failure. If this is a concern the RS-485 version should be used.

### 3.2.2 Connecting to a Host using RS-485

RS-485 communication allows connection of more than one drive to a single host PC, PLC, HMI or other computer. It also allows the communication cable to be long (more than 300 meters or 1000 feet). The use of Category 5 cable is recommended as it is widely used for computer networks, inexpensive, easily obtained and certified for quality and data integrity.

The TSM23S/Q can be used with either Two-Wire or Four-Wire RS-485 implementation. The connection can be point-to-point (i.e. one drive and one host) or a multi-drop network (one host and up to 32 drives).

**NOTE: To use the TSM23S/Q RS-485 version with the Step-Servo Quick Tuner software, it must be connected in the Four-Wire configuration (see below)**

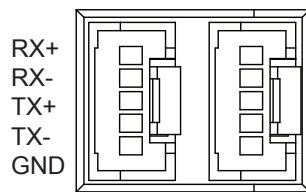

RS-485 Connector Diagram

#### Four-Wire Configuration

Four-Wire Systems utilize separate transmit and receive wires. One pair of wires must connect the host's transmit signals to each drive's RX+ and RX- terminals. The other pair connects the drive's TX+ and TX- terminals to the host's receive signals. A logic ground terminal is provided on each drive and can be used to keep all drives at the same ground potential. This terminal connects internally to the DC power supply return (V-), so **if all the drives on the RS-485 network are powered from the same supply, only one drive's GND terminal should be connected to the host computer ground, others' GND terminal must not connect the logic grounds.**

Because the host in a four-wire system never needs to disable its transmitter, software is simplified. Some converters make this process very difficult to implement and can delay communications.

**NOTE: If the PC does not have an RS-485 serial port, a converter is required. You can contact MOONS' to buy a USB to RS-485 converter.**

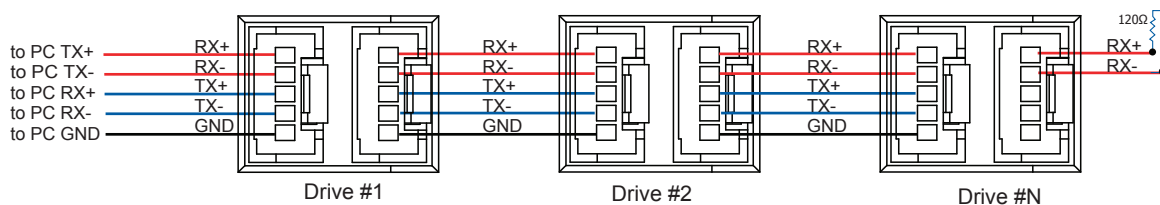

## Two-Wire Configuration

In a 2-wire system, the host must disable its transmitter before it can receive data. This must be done quickly before a drive begins to answer a query. The TSM23S/Q includes a transmit delay parameter that can be adjusted to compensate for a host that is slow to disable its transmitter. This adjustment can be made over the network using the TD command, or it can be set using the Step-Servo Quick Tuner software. It is not necessary to set the transmit delay in a four wire system.

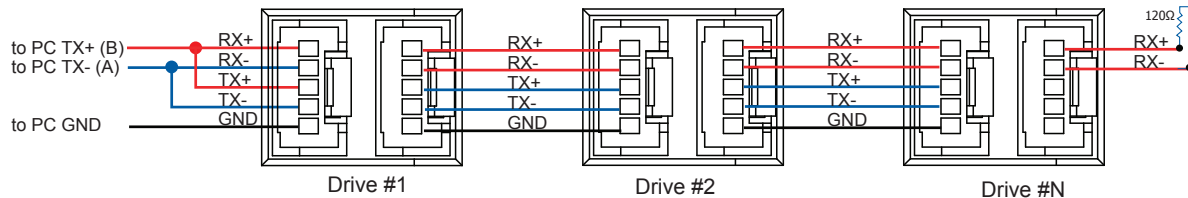

**NOTE: If the PC does not have an RS-485 serial port, a converter is required. You can contact MOONS' to buy a USB to RS-485 converter.**

## Assigning Addresses

Before the entire system is wired, each drive will need to connect individually to the host computer so that it can be assigned a unique address.

Once the drive has been connected to the PC as described above, launch the Step-Servo Quick Tuner software. Apply power to the drive. If a drive has already been configured, click the Upload button so that the Step-Servo Quick Tuner settings match those of the drive. When operating the drive in SCL mode it will need to be assigned an address. This is done on the Drive Configuration tab where a list of address options can be seen. The numerals 0..9 or the special characters ! " # \$ % & ' ( ) \* + , - . / : ; < = > ? @ may be used as addresses. Make sure each drive on the network has a unique address. On a 2-wire network, the Transmit Delay may also need to be set. Most adapters work well with 10 milliseconds. Once the address has been assigned, click Download to save the settings to the drive.

### 3.3 Inputs and Outputs

The TSM23S/Q has three types of inputs:

- High speed digital inputs for step & direction commands or encoder following, 5 to 24 volt logic
- Low speed digital input for other signals, 5 to 24 volt logic
- Analog input for analog speed and positioning modes

All drives include 8 digital inputs and 1 analog input

- X1/STEP & X2/DIR are high-speed digital inputs for commanding position. Quadrature signals from encoders can also be used. When not being used for the Step & Direction function these inputs can be used for CW & CCW step, (start/stop)/direction (oscillator mode), or general purpose input
- X3 & X4 are low speed software programmable input and can be used for Motor Enable/Disable and Alarm/Fault Reset function, or general purpose input
- X5/X6/X7/X8 are low speed software programmable input and can be used for CW/CCW Jog, CW/CCW Limit, Speed 1/Speed 2 (oscillator mode), or general purpose input
- AIN is an analog input for a velocity or position command signal. It can accept 0-5 volts and has gain, filtering, offset and dead-band settings.

#### 3.3.1 Connector Pin Diagram

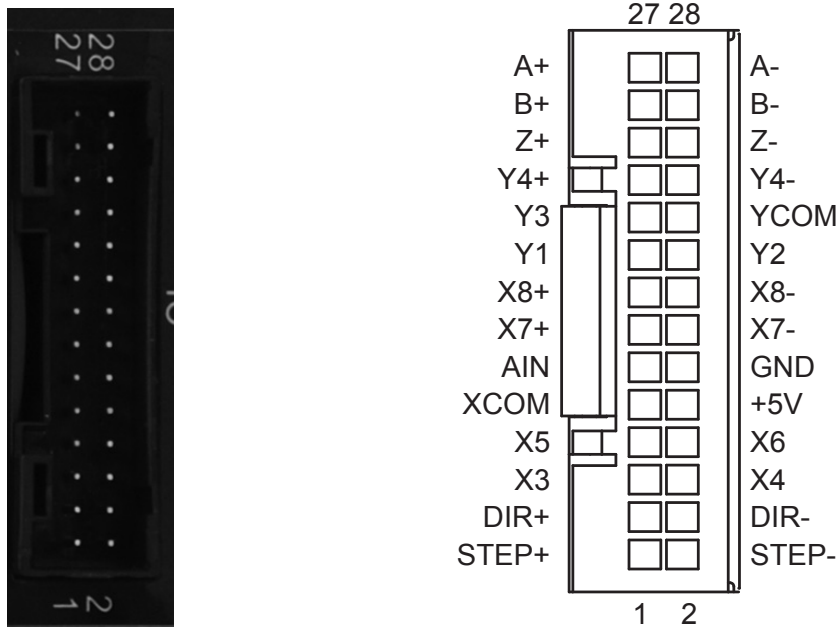

### 3.3.2 STEP & DIR Digital Inputs

The TSM24 drives include two high-speed inputs: X1/STEP and X2/DIR. They accept 5 to 24 volt single-ended or differential signals, up to 2 MHz. Typically these inputs connect to an external controller that provides step & direction command signals. You can also connect a master encoder to the high-speed inputs for “following” applications. Or you can use these inputs with Wait Input(WI), Feed to Sensor(FS), Seek Home(SH) and other SCL or Q commands.

The diagrams below show how to connect the STEP & DIR Inputs to various commonly used devices.

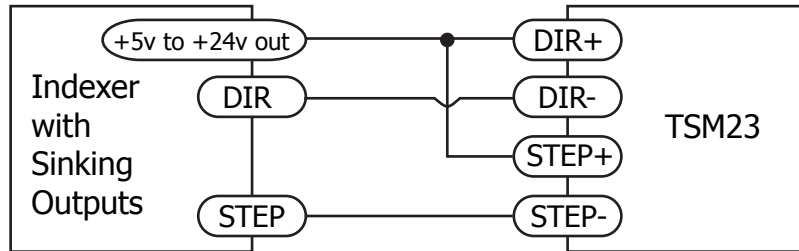

Connecting to Indexer with Sinking Outputs

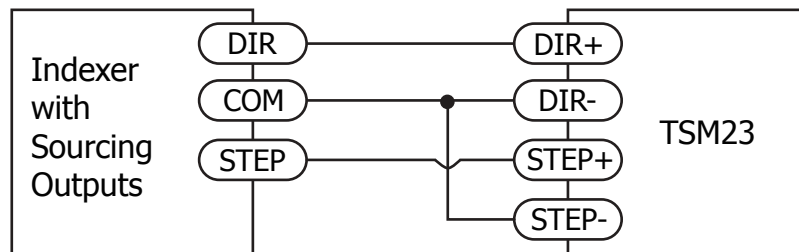

Connecting to Indexer with Sourcing Outputs

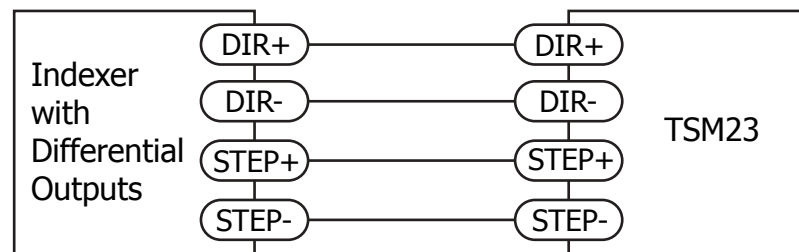

Connecting to Indexer with Differential Outputs  
Many high-speed indexers have differential outputs

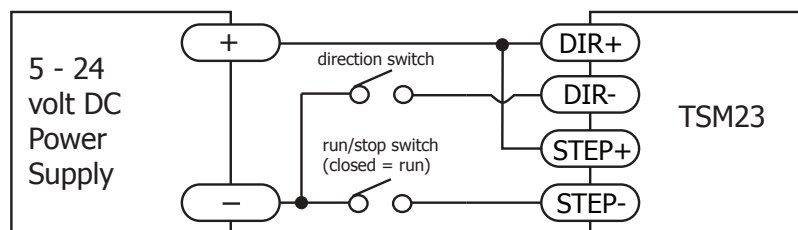

Using Mechanical Switches

### 3.3.3 X3/X4/X5/X6 Digital Input

While the STEP and DIR inputs are designed for high-speed digital input operation, the X3/X4/X5/X6 input are designed for low speed digital input operation between 5 and 24 volts optically Isolated Single-ended input. They can be used with sourcing or sinking signals, 5 to 24 volts. This allows connection to PLCs, sensors, relays and mechanical switches. Because the input circuits are isolated, they require a source of power. If you are connecting to a PLC, you should be able to get power from the PLC power supply. If you are using relays or mechanical switches, you will need a 5-24 V power supply.

#### What is COM?

“Common” is an electronics term for an electrical connection to a common voltage. Sometimes “common” means the same thing as “ground”, but not always. In the case of the TSM23 drives, if you are using sourcing (PNP) input signals, then you will want to connect COM to ground (power supply -). If you are using sinking (NPN) signals, then COM must connect to power supply +.

**Note: If current is flowing into or out of an input, the logic state of that input is low or closed. If no current is flowing, or the input is not connected, the logic state is high or open.**

The diagrams below show how to connect X3/X4/X5/X6 input to various commonly used devices.

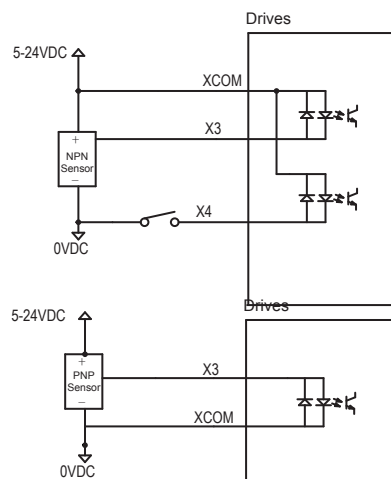
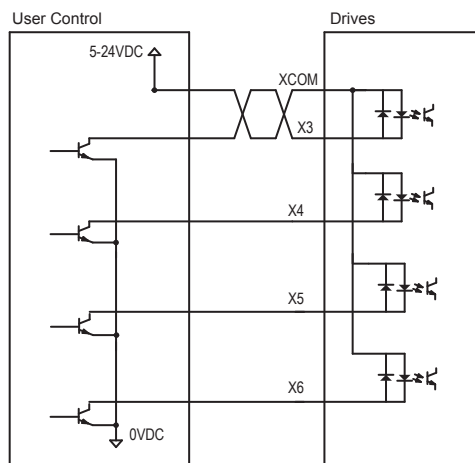

### 3.3.4 X7/X8 Digital Input

The X7/X8 input are designed for low speed digital input operation between 5 and 24 volts optically Isolated differential input. They are normally used for end of travel limit switches. The diagrams below show how to connect the X7/X8 Inputs to various commonly used devices

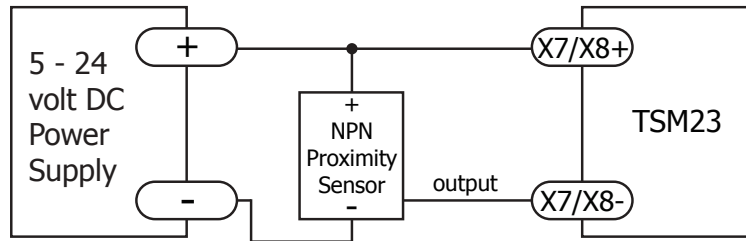

Connecting an NPN type Proximity Sensor to an Input  
(when prox sensor activates, input goes low)

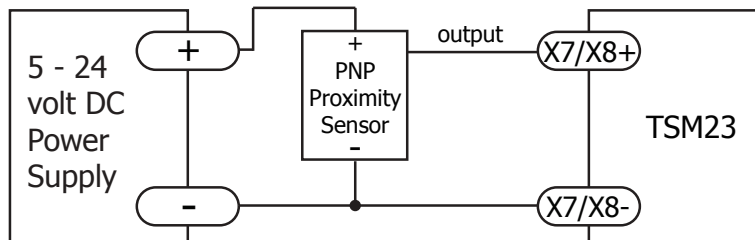

Connecting a PNP type Proximity Sensor to an Input  
(when prox sensor activates, input goes low)

### 3.3.5 AIN Input

The TSM23S/Q drives have an analog input (AIN) which can accept a signal range of 0 to 5 volts. The drive can be configured to operate at a speed or position that is proportional to the analog signal. Use the Step-Servo Quick Tuner software to set the signal range, offset, dead-band and filter frequency. The TSM23S/Q provides a +5 volt/100mA limit voltage supply that can be used to power external devices such as potentiometers. It is not the most accurate supply for reference, for more precise readings use an external supply that can provide the desired accuracy.

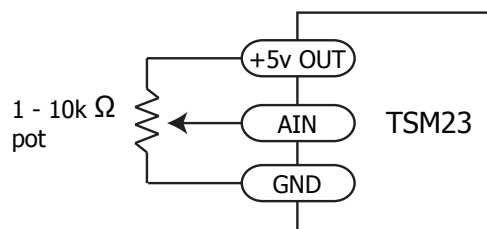
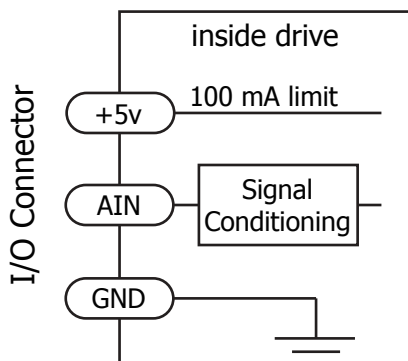

Connecting a Potentiometer to the Analog Input

### 3.3.6 Programmable Output Y1/Y2/Y3

The TSM23S/Q drives feature three optically isolated digital outputs (Y1 to Y3). Y1, Y2 and Y3 share a common terminal YCOM.

- Y1 can be set to signal a fault condition.
- Y2 can be set to indicate whether the motor is in position(dynamic).
- Y3 can be set to control a motor brake.

These outputs can also be turned on and off by program instructions like Set Output (SO). The output can be used to drive LEDs, relays and the inputs of other electronic devices like PLCs and counters. Diagrams of various connection types follow.

Do not connect the outputs to more than 30 volts. The current through each output terminal must not exceed 100mA.

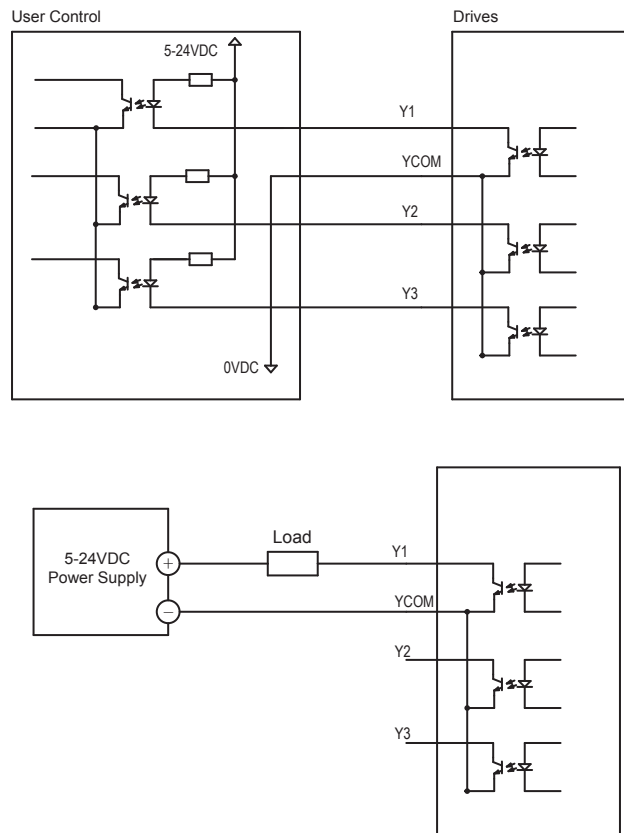

### 3.3.7 Programmable Output Y4

TSM23S/Q drives feature one optically isolated digital output Y4. The Y4+(collector) and Y4- (emitter) terminals of the transistor are available at the connector. This allow the output to be configured for current sourcing or sinking.

Y4 can be set to provide an output frequency proportional to motor speed (tach signal) or to provide a timing output (50 pulses/rev) or to indicate whether the motor is in position(static)

Diagrams of various connection types follow.

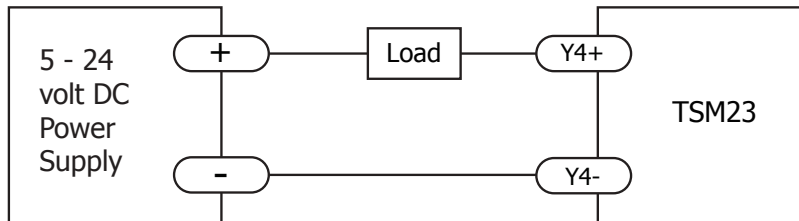

Connecting a Sinking Output

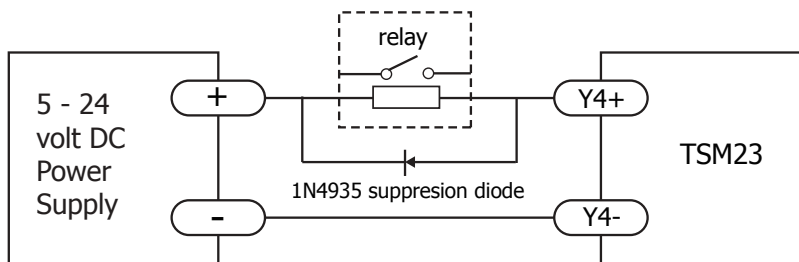
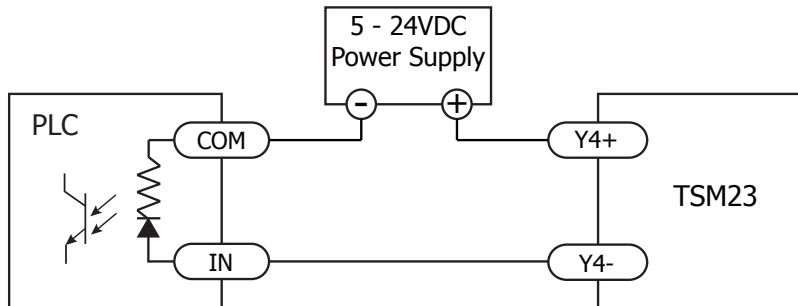



















Driving a Relay

**Do not connect the output to more than 30 volts. The current through the output terminal must not exceed 100mA.**

## 4 Troubleshooting

### LED Error Codes

The TSM23S/Q uses red and green LEDs to indicate status. When the motor is enabled, the green LED flashes slowly. When the green LED is solid, the motor is disabled. Errors are indicated by combinations of red and green flashes as shown below. This feature can be disabled for certain warnings but not for alarms. See software manual for information on how to do this and which warnings may be masked.

	Code	Error
	Solid green	no alarm, motor disabled
	Flashing green	no alarm, motor enabled
	1 red, 1 green	motor stall (optional encoder only)
	1 red, 2 green	Move while disabled
	2 red, 1 green	ccw limit
	2 red, 2 green	cw limit
	3 red, 1 green	drive overheating
	3 red, 2 green	internal voltage out of range
	3 red, 3 green	blank Q segment
	4 red, 1 green	power supply overvoltage or excess regen
	4 red, 2 green	power supply undervoltage
	4 red, 3 green	flash memory backup error
	5 red, 1 green	Over current/short circuit
	5 red, 2 green	Current foldback
	6 red, 1 green	Open motor winding
	6 red, 2 green	bad encoder signal (optional encoder only)
	7 red, 1 green	communication error
	7 red, 2 green	flash memory error

## 5 Reference Materials

### 5.1 Torque-Speed Curves

**Note: all torque curves were measured at 20,000 steps/rev.**

**Note: 5 amp rating is continuous, 7.5 amp rating is boost**

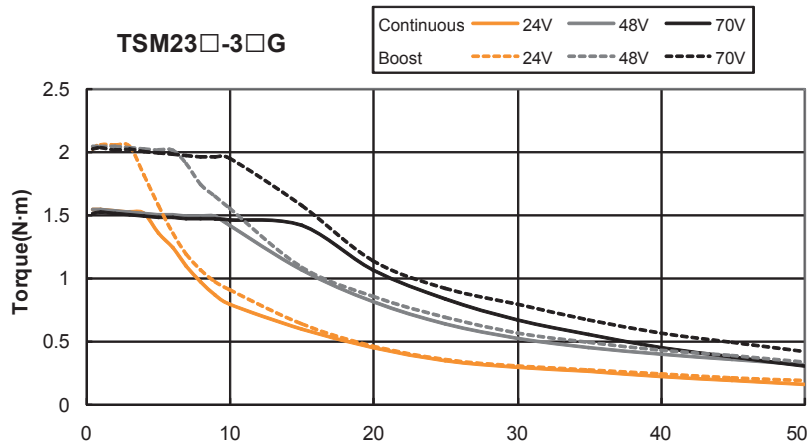
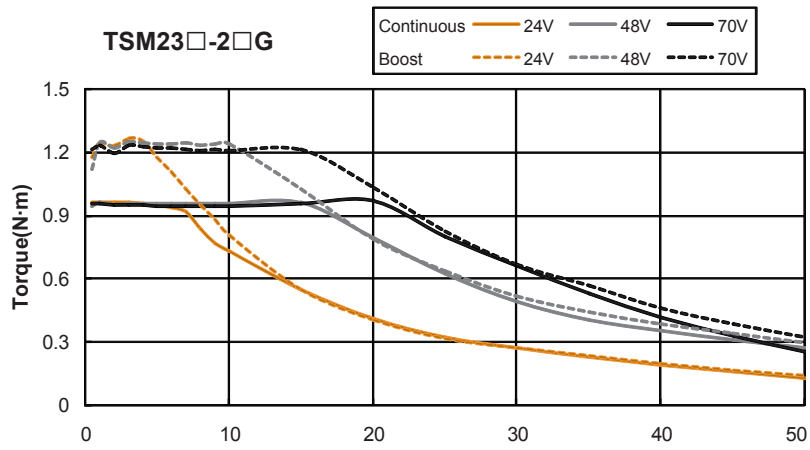

## 5.2 Mechanical Outlines

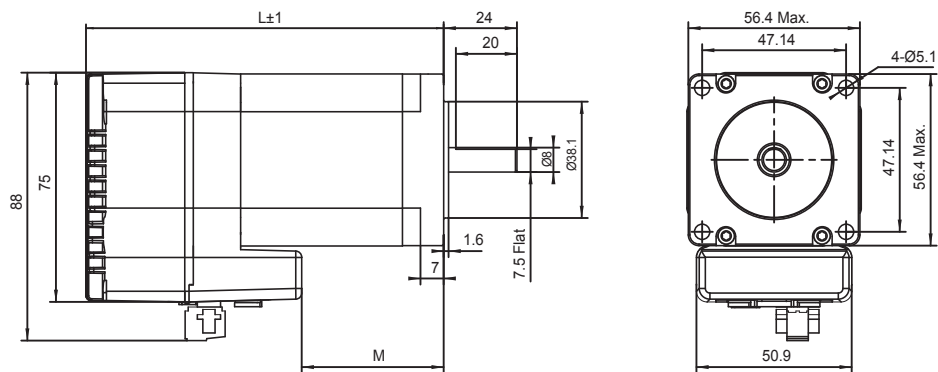

Unit:mm

Model	Length (L)	Length (M)
TSM23S/Q-2□G	95.6	24.6
TSM23S/Q-3□G	117.6	46.6

### 5.3 Technical Specifications

<b>Power Amplifier</b>	
Amplifier Type	Dual H-Bridge, 4 Quadrant
Current Control	4 state PWM at 20 KHz
Output Torque	TSM23S/Q-2□G: Up to 1.0N•m Continuous(1.3 N•m Boost) TSM23S/Q-3□G: Up to 1.5N•m Continuous(2.0 N•m Boost)
Power Supply	External 12 - 70 VDC power supply required
Protection	Over-voltage, under-voltage, over-temp, motor/wiring shorts (phase-to-phase, phase-to-ground)
<b>Controller</b>	
Electronic Gearing	Software selectable from 200 to 51200 steps/rev in increments of 2 steps/rev
Encoder Resolution	20000 counts/rev
Speed Range	Up to 3600rpm
Filters	Digital input noise filter, Analog input noise filter, Smoothing filter, PID filter, Notch filter
Non-Volatile Storage	Configurations are saved in FLASH memory on-board the DSP
Modes of Operation	TSM23S: Step & direction, CW/CCW pulse, A/B quadrature pulse, velocity (oscillator, joystick), streaming commands(SCL) TSM23Q: All TSM23S modes of operation plus stored Q program execution
Digital Inputs	Digital Inputs Adjustable bandwidth digital noise rejection filter on all inputs <b>X1/X2</b> : Optically isolated, 5-24 volt. Minimum pulse width = 250 ns, Maximum pulse frequency = 2 MHz Function: Pulse/Direction, CW/CCW Pulse, A/B quadrature (encoder following), (start/stop)/direction (oscillator mode), or general purpose input <b>X3/X4</b> : Optically isolated, 5-24 volt. Minimum pulse width = 100 μs, Maximum pulse frequency = 5 KHz Function: Servo on/off, Alarm/Fault Reset, or general purpose input <b>X5/X6/X7/X8</b> : Optically isolated, 5-24 volt. Minimum pulse width = 100 μs, Maximum pulse frequency = 5 KHz Function: CW/CCW Limit, Speed 1/Speed 2 (oscillator mode), or general purpose input
Digital Outputs	Y1/Y2/Y3/Y4: Optically isolated, 30V/100mA max Open Collector Output. Function: Alarm/Fault, In Position(dynamic/static), Brake Control, Tach out, Timing out, or general purpose usage
Encoder Output	Standard Line driver outputs, including A+/A-/B+/B-/Z+/Z- are supported
Analog Input	AIN referenced to GND. Range = 0 to 5 VDC. Resolution = 12 bits
Communication Interface	RS-232 or RS-485
<b>Physical</b>	
Ambient Temperature	0 to 40°C (32 to 104°F) When mounted to a suitable heatsink
Humidity	90% Max., non-condensing
Mass	TSM23S/Q-2□G: 850 g TSM23S/Q-3□G: 1200 g
Rotor Inertia	TSM23S/Q-2□G:260 g•cm <sup>2</sup> TSM23S/Q-3□G:460 g•cm <sup>2</sup>

## 5.4 SCL Command Reference

The Serial Command Language (SCL) was developed to give users a simple way to control a motor drive via a serial port. This eliminates the need for separate motion controllers or indexers to supply Pulse and Direction signals to the drive. It also provides an easy way to interface to a variety of other industrial devices such as PLCs and HMIs, which often have standard or optional serial ports for communicating to other devices. Some examples of typical host devices might be:

- A Windows based PC running MOONS' software
- An industrial PC running a custom or other proprietary software application
- A PLC with an ASCII module/serial port for sending text strings
- An HMI with a serial connection for sending text strings

SCL commands control the motion of the step motor, use of the inputs and outputs, and configure aspects of the drive such as motor current and microstep resolution.

In SCL mode, the TSM23S/Q receives commands from the host, executing them immediately or sending them to a command buffer and then executing them directly from the buffer. It cannot, however, create a stored program for stand-alone operation. For that function, the TSM23Q is needed.

The communications protocol of SCL is simple in that the host initiates all communication, with one exception. The only time the drive will initiate communication is at power-up. At that time, the drive will send an identifier to tell the software which drive is connected and what the firmware version is.

There are two types of SCL commands: buffered and immediate. Buffered commands are loaded into and then executed out of the drive's command buffer. Buffered commands are executed one at a time and in sequential order. The buffer can be filled with commands without the host controller needing to wait for a specific command to execute before sending the next command. Special buffer commands enable the buffer to be loaded and to pause for a desired time.

Immediate commands are not buffered, but are executed immediately, running in parallel with a buffered command if necessary. Immediate commands are designed to access the drive at any time and can be sent as often as needed. This allows a host controller to get information from the drive at a high rate, most often for checking drive status or motor position.

The basic structure of a command packet from the host to the drive is always a text string followed by a carriage return. The text string is composed of the command itself, followed by any required parameters. A carriage return denotes the end of transmission to the drive.

The syntax of the command is

**XXAB<cr>**

where **XX** designates the command (always composed of 2 uppercase letters), and **A** and **B** define the possible parameters. These parameters can vary in length, can be letters or numbers, and are often optional. Once a drive receives the **<cr>** (carriage return), it will determine whether or not it understood the command-if it did, it will either execute or buffer the command. The drive can also be programmed ahead of time to send a response as to whether or not it understood the command as well as any error code.

Some SCL commands transfer data to the drive for immediate or later use. These data values are stored in data registers and remain there until new commands change the values or power is removed from the drive. Some data registers in a drive are Read-Only and contain predefined information about the drive which can also be read through SCL commands.

Because of the intense nature of serial communications required in host mode applications, there is a serial communication Protocol (PR) command available that will adjust a drive's serial communications protocol to best fit an application. Typically this command is used when configuring a drive and saved as part of the startup parameters. But it can be used at any time to dynamically alter the serial communications.

The SCL Utility Software Manual contains the complete command listing as well as instructions on connecting and configuring the TSM23S/Q for use in SCL mode, using the Data Registers and the Protocol command. It also contains detailed information on:

- Host Serial Communications
- Host Serial Connections
- Alarm and Status Codes
- Working with Inputs and Outputs

The Manual is available from the MOONS' website at <http://www.moonsindustries.com/Products/Drives/Software/>

under the SCL Utility download section.

## 6 Contacting MOONS'



**Service Center**  
**+86-400-820-9661**

### ■ Headquarters

No. 168 Mingjia Road Industrial Park North Minhang District Shanghai 201107, P.R. China  
Tel: +86(0)21-52634688  
Fax: +86(0)21-62968682  
E-mail: info@moons.com.cn

### ■ MOONS' Industries (America), Inc.

1113 North Prospect Avenue, Itasca, IL 60143 U.S.A.  
Tel: 001-630-833-5940  
Fax: 001-630-833-5946

### ■ MOONS' Industries (Europe) S.r.l.

Via Torri Bianche n.1 20059 Vimercate(MB) Italy  
Tel: +39 039 62 60 521  
Fax: +39 039 96 31 409

### ■ MOONS' Industries (South-East Asia) Pte Ltd.

33 Ubi Avenue 3 #08-23 Vertex Singapore 408868  
Tel: +65 6634 1198  
Fax: +65 6634 1138

### ■ Shenzhen Branch Office

Room 2209, 22/F, Kerry Center, No. 2008 Renminnan Road Shenzhen 518001 P. R.China  
Tel: +86 (0)755 25472080  
Fax: +86 (0)755 25472081

### ■ Beijing Branch Office

Room 202, Unit 2, 7th Building, Huilongsen International Science & Technology Industry Park,  
No.99, Kechuang 14th Street, Beijing 101111 P. R.China  
Tel: +86 (0)10 59755578  
Fax: +86 (0)10 59755579

### ■ Qingdao Branch Office

Room 10E, No.73 Wangjiao Mansion, mid. Hongkong Road Qingdao 266071 P. R.China  
Tel: +86 (0)532 85879625  
Fax: +86 (0)532 85879512

### ■ Wuhan Branch Office

Room 3001, World Trade Tower, No.686 Jiefang Avenue, Jiangnan District, Wuhan 430022 P.R.China  
Tel: +86 (0)27-85448742  
Fax: +86 (0)27-85448355

### ■ Nanjing Branch Office

Room 302, Building A, Tengfei Creation Center, 55 Jiangjun Avenue, Jiangning District, Nanjing 211100  
P. R.China  
Tel: +86 (0)25 52785841  
Fax: +86 (0)25 52785485

### ■ Chengdu Branch Office

Room 1917, Western Tower, No.19, 4th Section of South People Road, Wuhou District, Chengdu 610041  
P.R.China  
Tel: +86 (0)28-85268102  
Fax: +86 (0)28-85268103

### ■ Xi'an Branch Office

Room 1006, Block D, Wangzuo International City, No.1 Tangyan Road, Xi'an 710065 P.R. China  
Tel: +86 (0)29 81870400  
Fax: +86 (0)29 81870340