TSM17P

Integrated Step-Servo Motor



Hardware Manual
Rev. 0.1

AMP & MOONS' Automation

Contents

1	Introduction	5
1.1	Features	5
1.2	Block Diagram	6
1.3	Safety Instructions	7
2	Getting Started	8
2.1	Installing Software	8
2.2	Mounting the Hardware	8
2.3	Choosing a Power Supply	9
2.3.1	Voltage	9
2.3.2	Regeneration Clamp	9
2.3.3	Current	10
3	Installation/Connections	14
3.1	Connecting the Power Supply	14
3.2	Connecting the TSM17P Communications	15
3.2.1	Connecting to the PC using RS-232	15
3.3	Inputs and Outputs	15
3.3.1	Connector Pin Diagram	15
3.3.2	X1/STEP and X2/DIR High Speed Digital Inputs	17
3.3.3	X3/EN and X4/AR Digital Inputs	18
3.3.4	Programmable Outputs	19
4	Troubleshooting	20
5	Reference Materials	21
5.1	Mechanical Outlines	21
5.2	Technical Specifications	22
5.3	Torque-Speed Curves	23
6	Contacting MOONS'	24

Model	Communications
	RS-232
TSM17P-1AG	√
TSM17P-2AG	√
TSM17P-3AG	√

1 Introduction

Thank you for selecting the MOONS' TSM17P Integrated Motor. The TSM line of integrated step-servo motors combines servo technology with an integrated motor to create a product with exceptional feature and broad capability. We hope our commitment to performance, quality and economy will result in a successful motion control project.



1.1 Features

- Programmable, Digital servo driver and motor in an integrated package
- Operates from a 12 to 48 volt DC power supply
- Control Modes:
 - * Position Control
 - * Digital Signal type
 - Step & Direction
 - CW & CCW pulse
 - A/B Quadrature (Encoder Following)
- Communications:
 - * RS-232
- 5000 line (20,000 counts/rev) encoder feedback
- Available torque:
 - * TSM17P-1AG: Up to 0.28N•m Continuous(0.35 N•m Boost)
 - * TSM17P-2AG: Up to 0.42N•m Continuous(0.52 N•m Boost)
 - * TSM17P-3AG: Up to 0.52N•m Continuous(0.68 N•m Boost)
- I/O:
 - * 4 optically isolated digital inputs, with adjustable bandwidth digital noise rejection filter, 5 to 24 volts
 - * 3 optically isolated digital outputs, 30V/100 mA max.
 - * Differential encoder outputs (A±, B±, Z±), 26C31 line driver, 20 mA sink or source max
- Technological advances:
 - * Full servo control, Closed loop
 - * Efficient, Accurate, Fast, Smooth
 - * Intelligent, Compact

1.2 Block Diagram

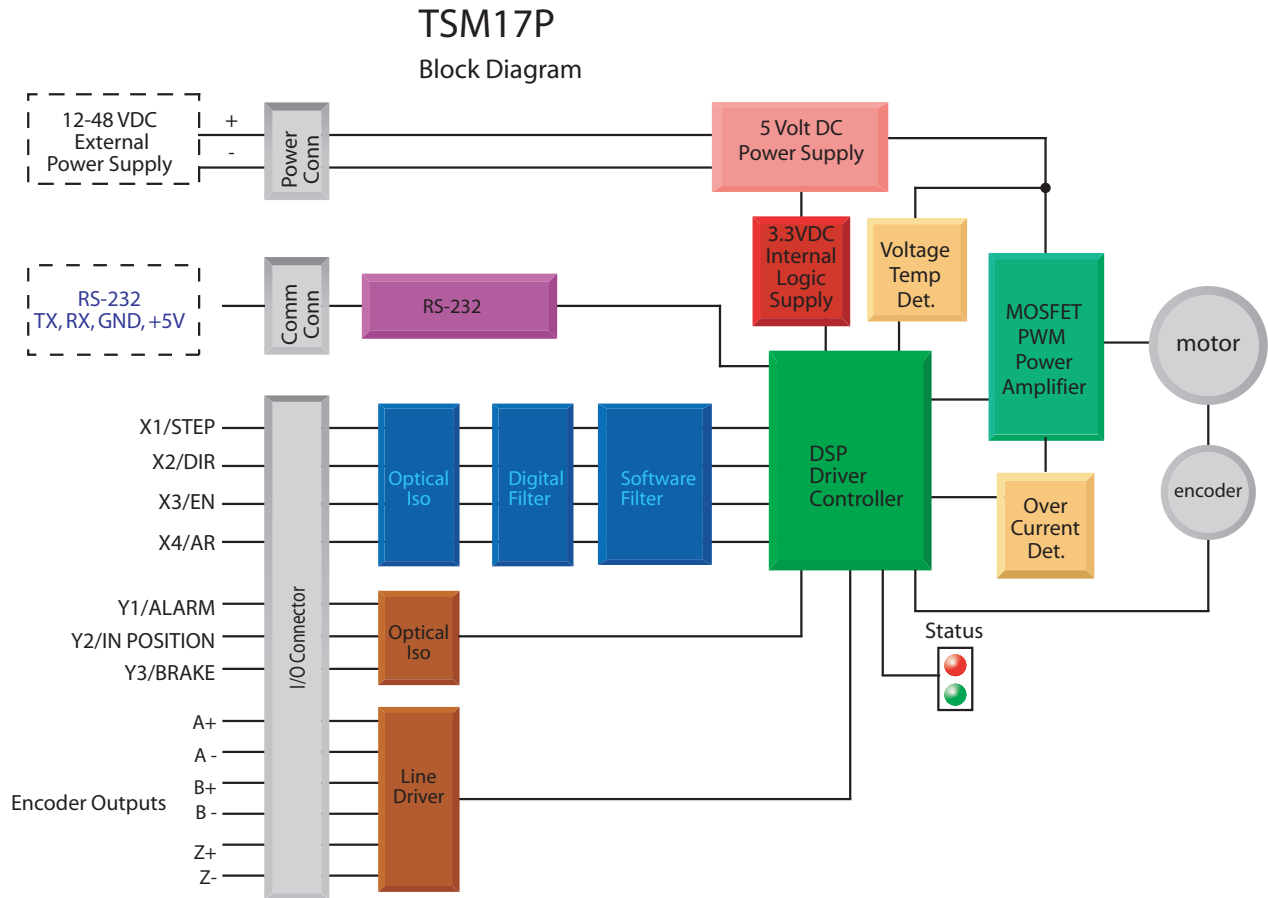

1.3 Safety Instructions

Only qualified personnel should transport, assemble, install, operate, or maintain this equipment. Properly qualified personnel are persons who are familiar with the transport, assembly, installation, operation, and maintenance of motors, and who meet the appropriate qualifications for their jobs.

To minimize the risk of potential safety problems, all applicable local and national codes regulating the installation and operation of equipment should be followed. These codes may vary from area to area and it is the responsibility of the operating personnel to determine which codes should be followed, and to verify that the equipment, installation, and operation are in compliance with the latest revision of these codes.

Equipment damage or serious injury to personnel can result from the failure to follow all applicable codes and standards. MOONS' does not guarantee the products described in this publication are suitable for a particular application, nor do they assume any responsibility for product design, installation, or operation.

Read all available documentation before assembly and operation. Incorrect handling of the products referenced in this manual can result in injury and damage to persons and machinery. All technical information concerning the installation requirements must be strictly adhered to.

It is vital to ensure that all system components are connected to earth ground. Electrical safety is impossible without a low-resistance earth connection.

This product contains electrostatically sensitive components that can be damaged by incorrect handling. Follow qualified anti-static procedures before touching the product.

During operation keep all covers and cabinet doors shut to avoid any hazards that could possibly cause severe damage to the product or personal health.

During operation, the product may have components that are live or have hot surfaces.

Never plug in or unplug the Integrated Motor while the system is live. The possibility of electric arcing can cause damage.

Be alert to the potential for personal injury. Follow recommended precautions and safe operating practices emphasized with alert symbols. Safety notices in this manual provide important information. Read and be familiar with these instructions before attempting installation, operation, or maintenance. The purpose of this section is to alert users to the possible safety hazards associated with this equipment and the precautions necessary to reduce the risk of personal injury and damage to equipment. Failure to observe these precautions could result in serious bodily injury, damage to the equipment, or operational difficulty.

2 Getting Started

The following items are needed:

- A 12 - 48 volt DC power supply, see the section below entitled “Choosing a Power Supply” for help in choosing the right one
- A small flat blade screwdriver for tightening the connectors (included)
- A PC running Microsoft Windows 2000, XP, Vista, or Windows 7
- A MOONS' programming cable (included)

2.1 Installing Software

Before utilizing the TSM17P Integrated Step-Servo Motor and Step-Servo Quick Tuner Software in an application, the following steps are necessary:

- Download and install the Step-Servo Quick Tuner software from MOONS' website.
- Connect the drive to the PC using the programming cable.
- Connect the drive to the power supply. See instructions below.
- Launch the software by clicking Start...Programs...MOONS'.
- Apply power to the drive.
- The software will recognize the drive and display the model and firmware version. At this point, it is ready for use.

2.2 Mounting the Hardware

As with any step motor, the TSM17P must be mounted so as to provide maximum heat sinking and airflow. Keep enough space around the Integrated Motor to allow for airflow.



- Never use the drive where there is no airflow or where other devices cause the surrounding air to be more than 40°C (104°F).
- Never put the drive where it can get wet.
- Never use the drive where metal or other electrically conductive particles can infiltrate the drive.
- Always provide airflow around the drive.

2.3 Choosing a Power Supply

The main considerations when choosing a power supply are the voltage and current requirements for the application.

2.3.1 Voltage

The TSM17P is designed to give optimum performance between 24 and 48 Volts DC. Choosing the voltage depends on the performance needed and motor/drive heating that is acceptable and/or does not cause a drive over-temperature. Higher voltages will give higher speed performance but will cause the TSM17P to produce higher temperatures. Using power supplies with voltage outputs that are near the drive maximum may significantly reduce the operational duty-cycle.

The extended range of operation can be as low as 10 VDC minimum to as high as 55 VDC maximum. When operating below 10 VDC, the power supply input may require larger capacitance to prevent under-voltage and internal-supply alarms. Current spikes may make supply readings erratic. The supply input cannot go below 10 VDC for reliable operation. Absolute minimum power supply input is 10 VDC. If the Input supply drops below 10 VDC the low voltage alarm will be triggered. This will not fault the drive.

Absolute maximum power supply input is 55 VDC at which point an over-voltage alarm and fault will occur. When using a power supply that is regulated and is near the drive maximum voltage of 55 VDC, a voltage clamp may be required to prevent over-voltage when regeneration occurs. When using an unregulated power supply, make sure the no-load voltage of the supply does not exceed the drive's maximum input voltage of 55 VDC.

2.3.2 Regeneration Clamp

If a regulated power supply is being used, there may be a problem with regeneration. When a load decelerates rapidly from a high speed, some of the kinetic energy of the load is transferred back to the power supply, possibly tripping the over-voltage protection of a regulated power supply, causing it to shut down. This problem can be solved with the use of a MOONS' RC880 Regeneration Clamp. It is recommended that an RC880 initially be installed in an application. If the "regen" LED on the RC880 never flashes, the clamp is not necessary.

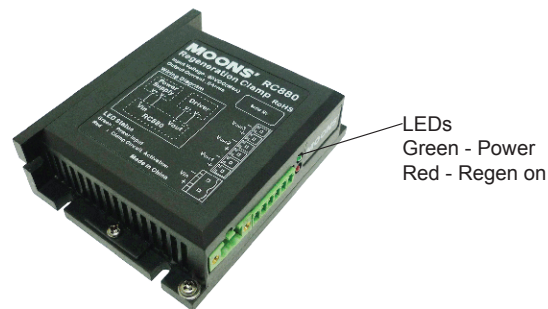

RC880 Regen Clamp

2.3.3 Current

The maximum supply currents required by the TSM17P are shown in the charts below at different power supply voltage inputs. The TSM17P power supply current is lower than the winding currents because it uses switching amplifiers to convert a high voltage and low current into lower voltage and higher current. The more the power supply voltage exceeds the motor voltage, the less current will be required from the power supply.

It is important to note that the current draw is significantly different at higher speeds depending on the torque load to the motor. Estimating how much current is necessary may require a good analysis of the load the motor will encounter.

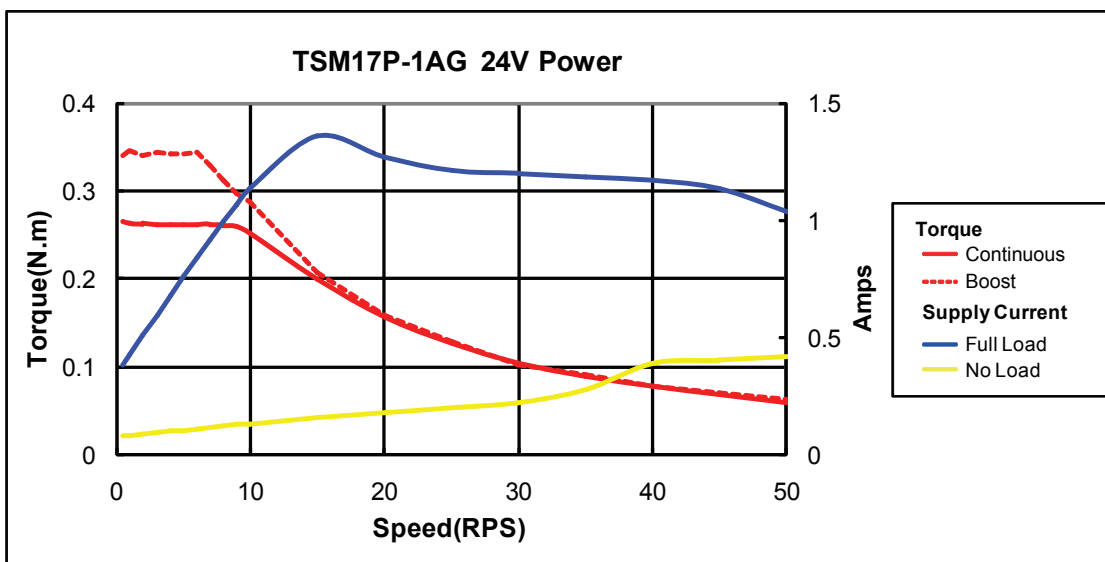
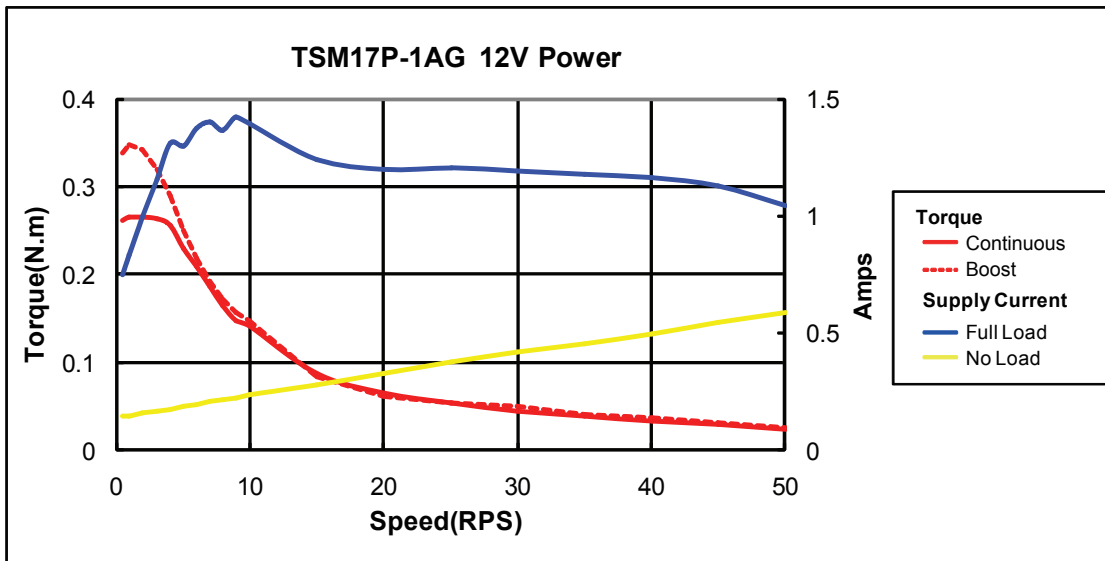

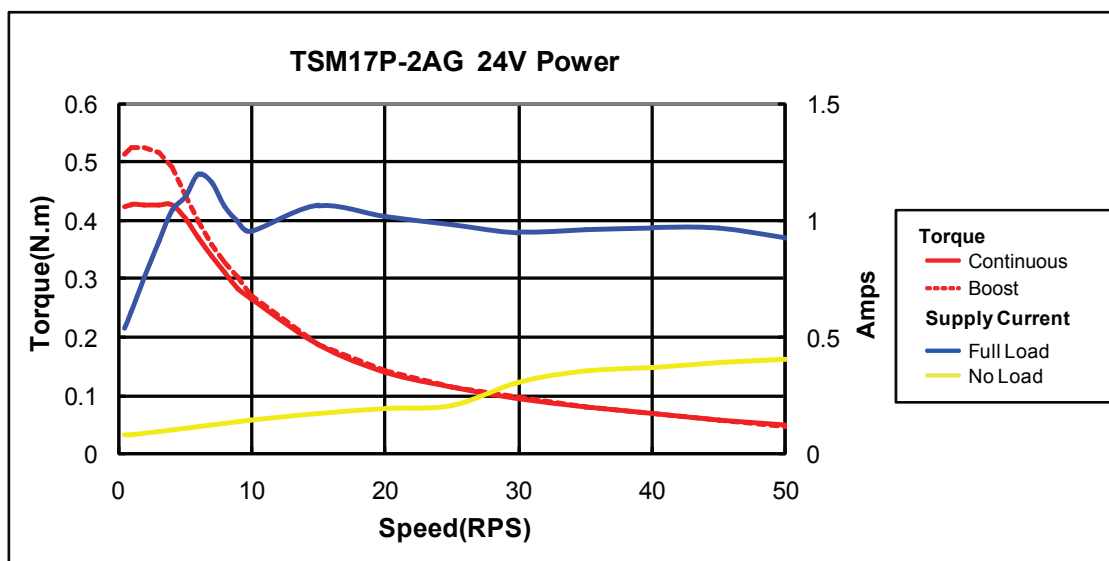
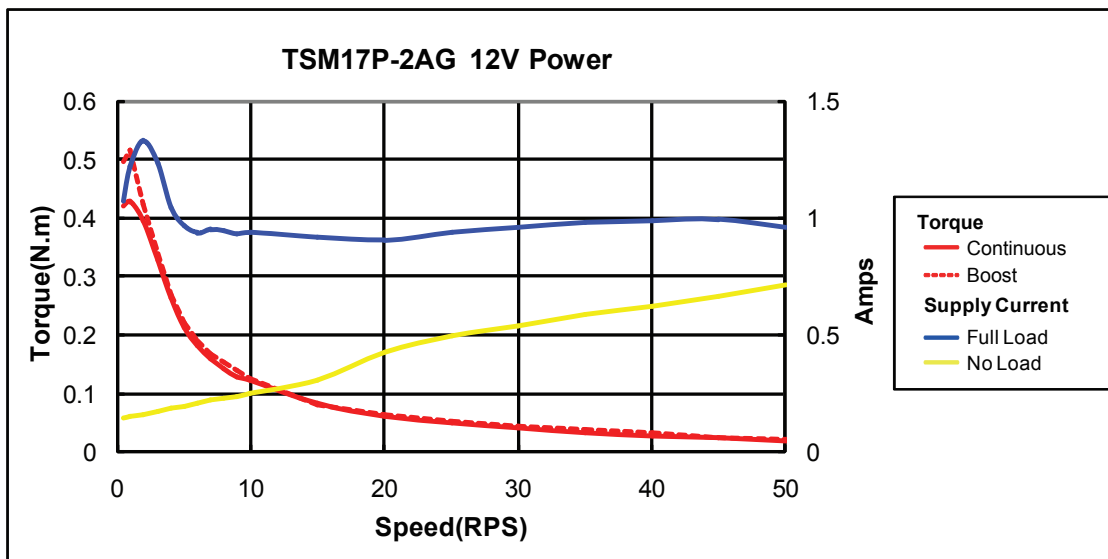
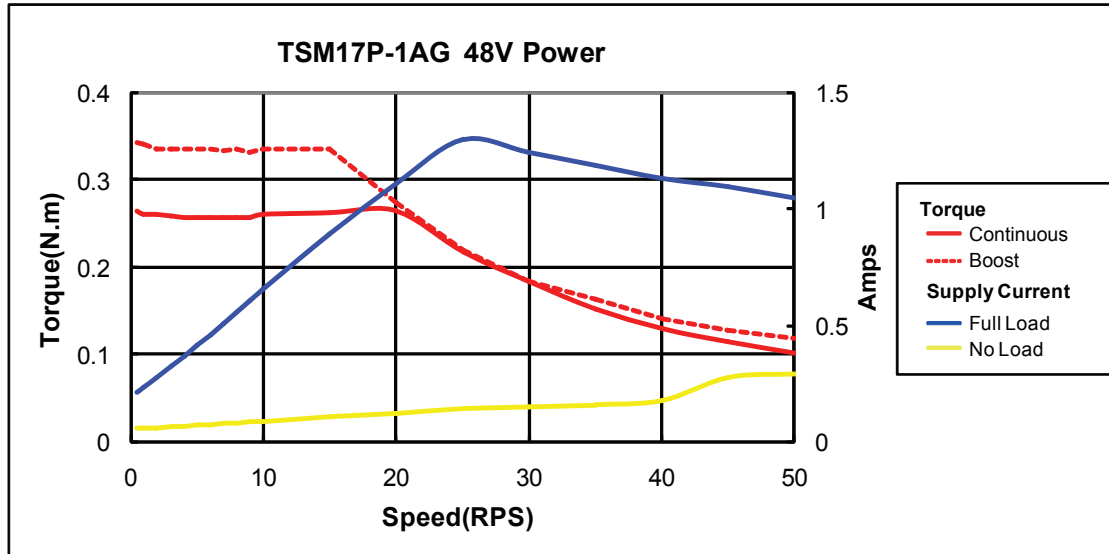

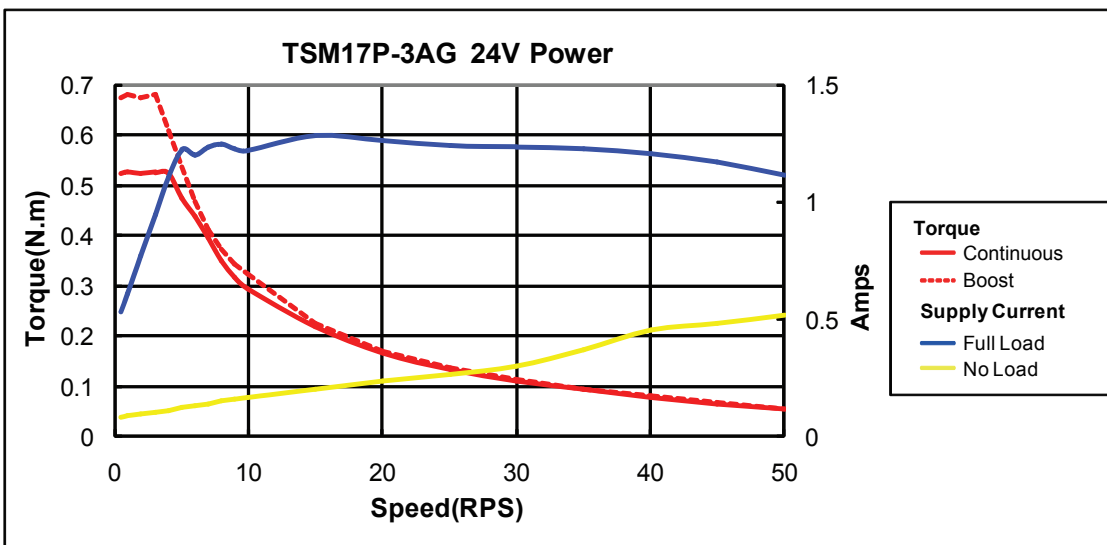
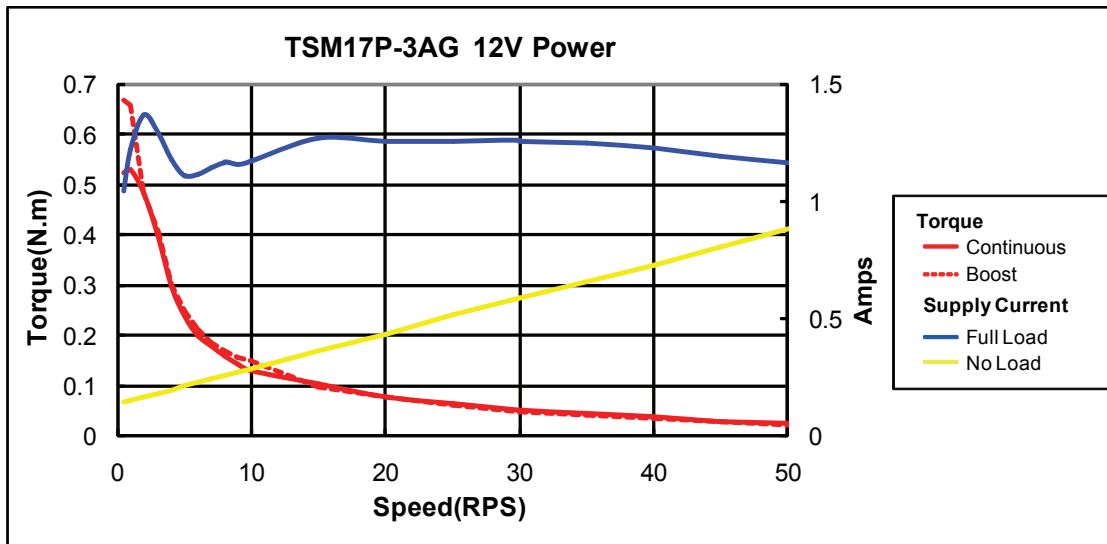
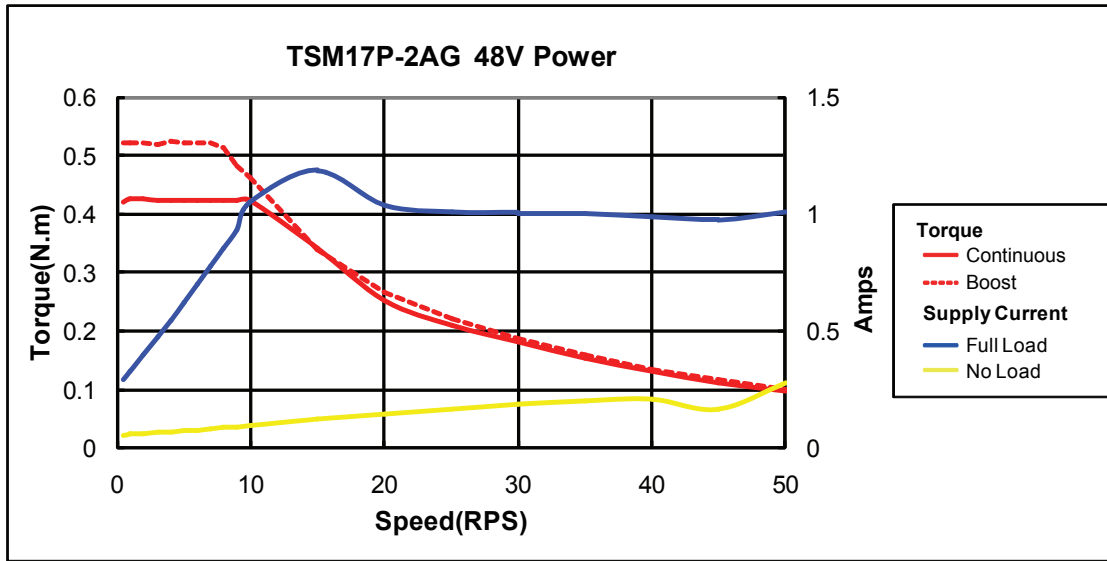

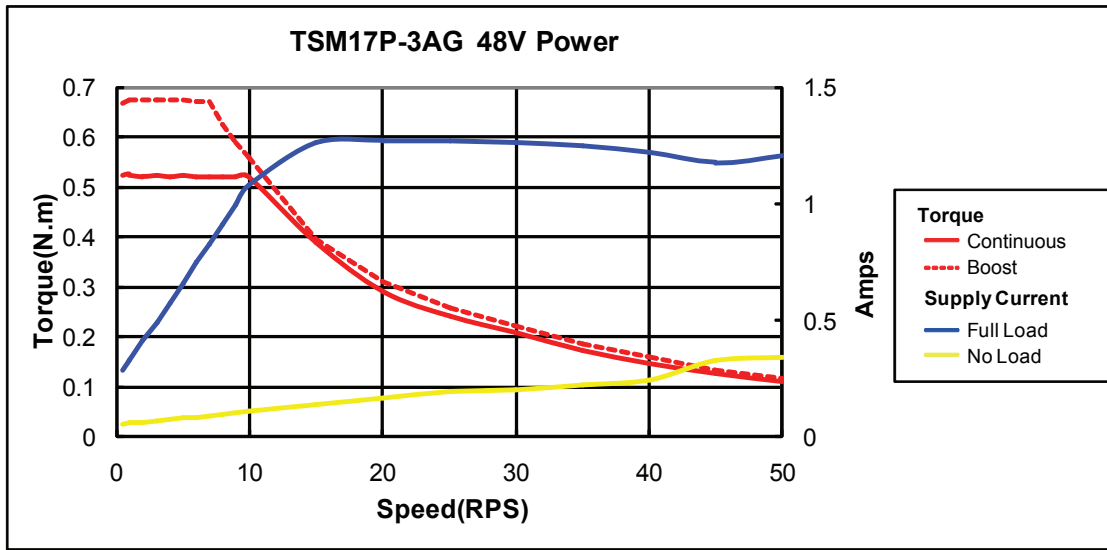

3 Installation/Connections

3.1 Connecting the Power Supply

Use 16 to 20-gauge wire to connect the TSM17 to a power supply. It contains an internal fuse connected to the “+” terminal that is not user replaceable. If a user serviceable fuse is desired, install a 6.3 amp fast acting fuse in line with the “+” power supply lead.



Be careful not to reverse the wires. Reversing the connection may open the internal fuse on the drive and void the warranty.

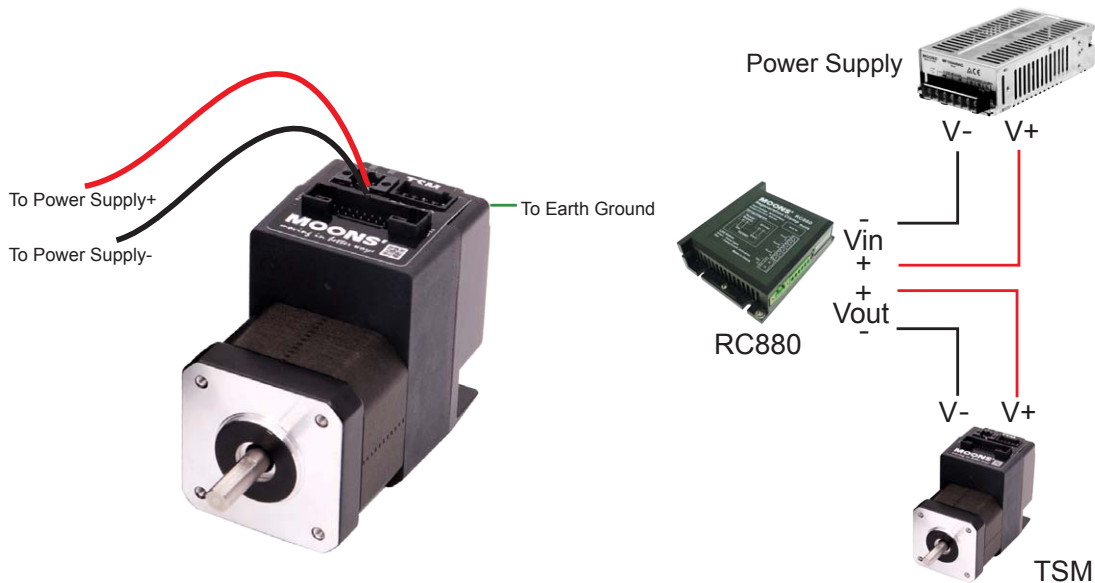

MOONS' offers two matched power supplies for use with the TSM17P.

A 24VDC, 150W(P/N MF150A24AG-V) and a 48VDC 320W(P/N MF320A48AG-V).

These power supplies have current over load capability making them ideal for use.

(To use with a switch power supplier, a RC880 regen must be connected in system)

The RC880 regeneration clamp is for use where regeneration from the motor may cause damage to the drive. In these cases the RC880 is connected between the drive and power supply and absorbs regenerated energy.

3.2 Connecting the TSM17P Communications

The TSM17P comes with a cable that will provide the interface to an RS-232 port through a DB9 style connector.

3.2.1 Connecting to the PC using RS-232

Locate the TSM17P within 2.5 meters of the PC. Plug the DB9 connector of the communication cable that came with the drive into the serial port of the PC. Plug the small end into the crimp style connector on the TSM17P . Secure the cable to the PC with the screws on the DB9 connector.

Note: If the PC does not have an RS-232 serial port, a USB Serial Converter will be needed. You can contact MOONS' to buy a USB to RS-232 converter.

The RS-232 circuitry does not have any extra electrical “hardening” and care should be taken when connecting to the RS-232 port as hot plugging could result in circuit failure.

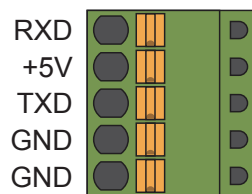

3.3 Inputs and Outputs

TSM17P drives include 4 digital inputs

X1/STEP & X2/DIR are high-speed 5-24 volt logic digital inputs for commanding position. Quadrature signals from encoders can also be used.

X3/EN and X4/AR are 5-24 volt logic digital inputs. X3/EN is used for motor enable/disable. X4/AR is used for alarm reset.

3.3.1 Connector Pin Diagram

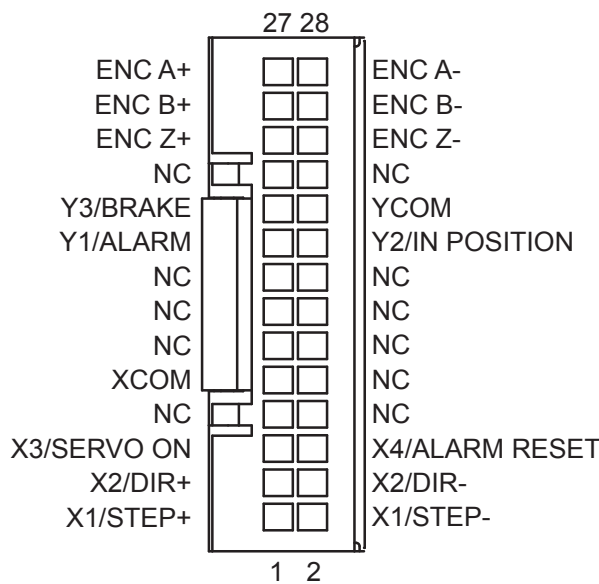

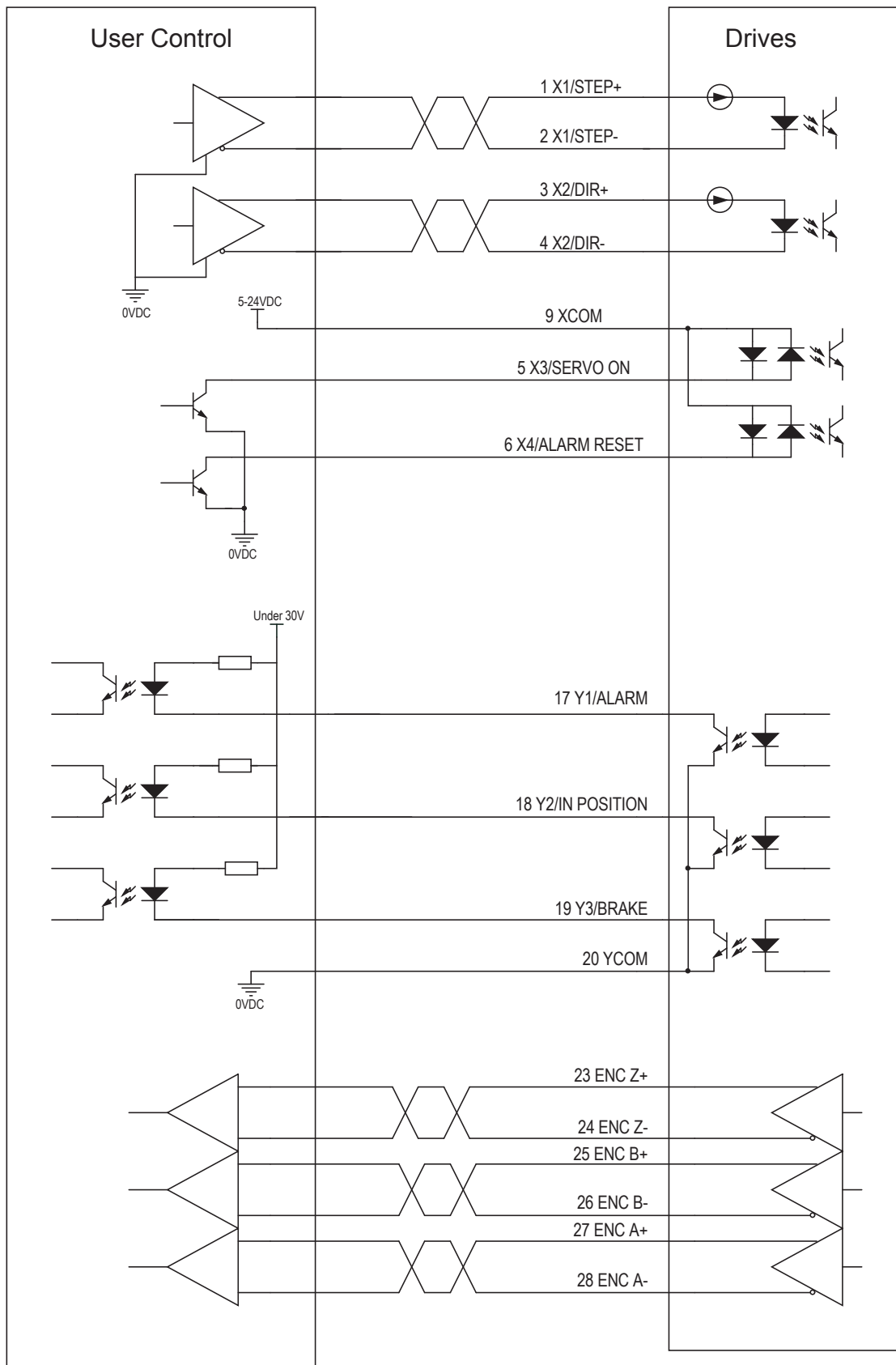

3.3.2 X1/STEP and X2/DIR High Speed Digital Inputs

The TSM17 drives include two high-speed inputs: X1/STEP and X2/DIR. They accept 5 to 24 volt single-ended or differential signals, up to 2 MHz. Typically these inputs connect to an external controller that provides step & direction command signals. You can also connect a master encoder to the high-speed inputs for “following” applications.

The diagrams below show how to connect the STEP & DIR Inputs to various commonly used devices.

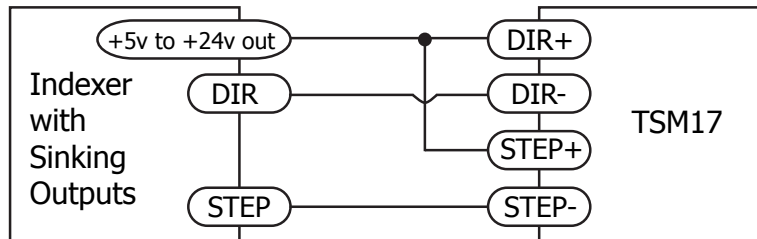

Connecting to Indexer with Sinking Outputs

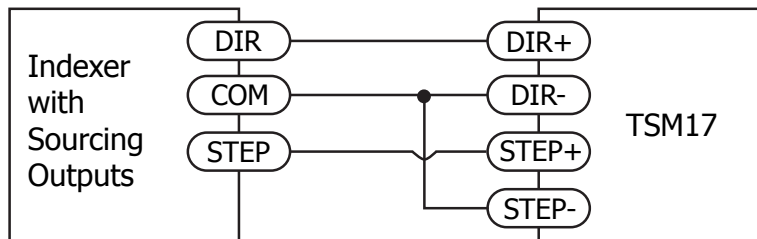

Connecting to Indexer with Sourcing Outputs

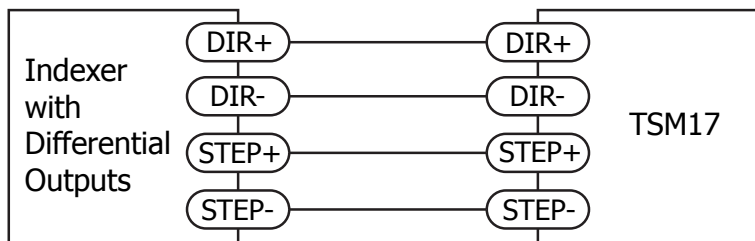

Connecting to Indexer with Differential Outputs
Many high-speed indexers have differential outputs

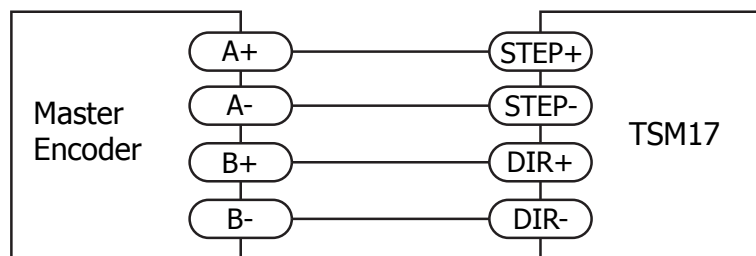

Wiring for Encoder Following

3.3.3 X3/EN and X4/AR Digital Inputs

The TSM17 drives include two single ended inputs: X3/EN and X4/AR. They can be used with sourcing or sinking signals, 5 to 24 volts. This allows connection to PLCs, sensors, relays and mechanical switches. Because the input circuits are isolated, they require a source of power. If you are connecting to a PLC, you should be able to get power from the PLC power supply. If you are using relays or mechanical switches, you will need a 5-24 V power supply.

What is COM?

“Common” is an electronics term for an electrical connection to a common voltage. Sometimes “common” means the same thing as “ground”, but not always. In the case of the TSM17 drives, if you are using sourcing (PNP) input signals, then you will want to connect COM to ground (power supply -). If you are using sinking (NPN) signals, then COM must connect to power supply +.

Note: If current is flowing into or out of an input, the logic state of that input is low or closed. If no current is flowing, or the input is not connected, the logic state is high or open.

The diagrams below show how to connect the inputs to various commonly used devices.

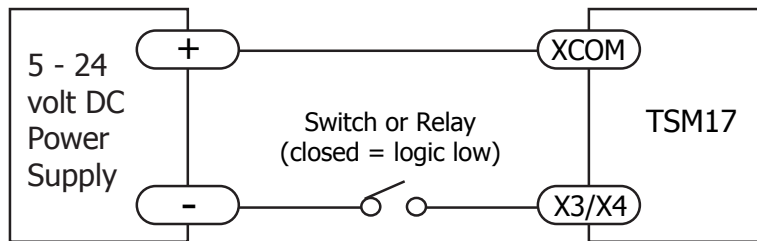

Connecting the Input to a Switch or Relay

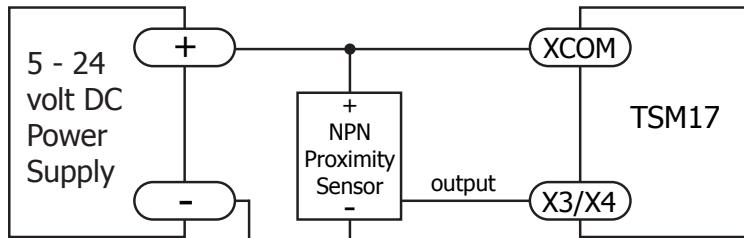

Connecting an NPN type Proximity Sensor to an Input
(when prox sensor activates, input goes low)

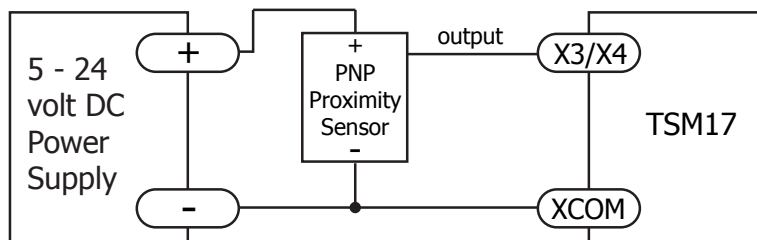

Connecting a PNP type Proximity Sensor to an Input
(when prox sensor activates, input goes low)

3.3.4 Programmable Outputs

The TSM17P drives feature three optically isolated digital outputs (Y1 to Y3). Y1, Y2 and Y3 share a common terminal YCOM.

- Y1 can be set to signal a fault condition.
- Y2 can be set to indicate whether the motor is in position(dynamic).
- Y3 can be set to control a motor brake, or to provide an output frequency proportional to motor speed (tach signal) or to provide a timing output (50 pulses/rev) or to indicate whether the motor is in position(static)

These outputs can also be turned on and off by program instructions like Set Output (SO). The output can be used to drive LEDs, relays and the inputs of other electronic devices like PLCs and counters. Diagrams of various connection types follow.

Do not connect the outputs to more than 30 volts. The current through each output terminal must not exceed 100mA.

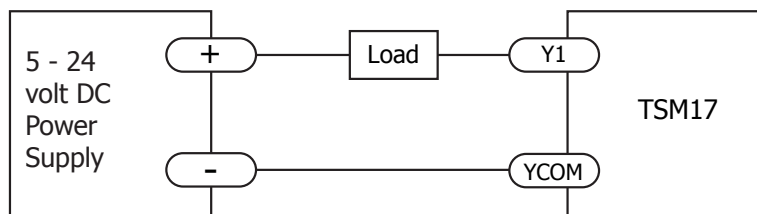

Connecting a Sinking Output

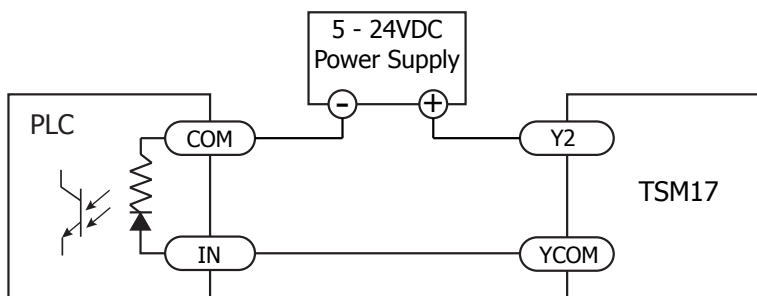

Connecting a Sourcing Output

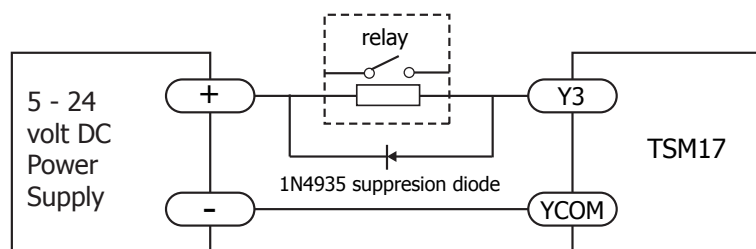



















Driving a Relay

4 Troubleshooting

LED Error Codes

The TSM17P uses red and green LEDs to indicate status. When the motor is enabled, the green LED flashes slowly. When the green LED is solid, the motor is disabled. Errors are indicated by combinations of red and green flashes as shown below. This feature can be disabled for certain warnings but not for alarms. See software manual for information on how to do this and which warnings may be masked.

	Code	Error
	solid green	motor disabled
	flashing green	motor enabled
	1 red, 1 green	position limit
	1 red, 2 green	drive disabled
	2 red, 1 green	ccw limit
	2 red, 2 green	cw limit
	3 red, 1 green	over temperature
	3 red, 2 green	internal voltage bad
	3 red, 3 green	non-volatile memory error
	4 red, 1 green	over voltage
	4 red, 2 green	under voltage
	4 red, 3 green	non-volatile double error
	5 red, 1 green	over current
	5 red, 2 green	current limit
	6 red, 1 green	open winding
	6 red, 2 green	encoder failure
	7 red, 1 green	communication error
	7 red, 2 green	save failed

5 Reference Materials

5.1 Mechanical Outlines

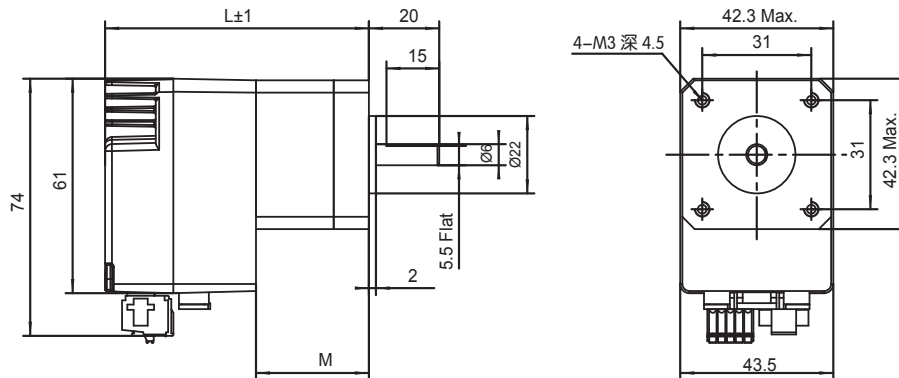

Model	Length "L"	Length "M"
TSM17P-1AG	69.5	26.6
TSM17P-2AG	75	32.1
TSM17P-3AG	83.5	40.6

5.2 Technical Specifications

Power Amplifier	
Amplifier Type	Dual H-Bridge, 4 Quadrant
Current Control	4 state PWM at 20 KHz
Output Torque	TSM17P-1AG: Up to 0.28N•m Continuous(0.35 N•m Boost) TSM17P-2AG: Up to 0.42N•m Continuous(0.52 N•m Boost) TSM17P-3AG: Up to 0.52N•m Continuous(0.68 N•m Boost)
Power Supply	External 12 - 48 VDC power supply required
Protection	Over-voltage, under-voltage, over-temp, motor/wiring shorts (phase-to-phase, phase-to-ground)
Controller	
Electronic Gearing	Software selectable from 200 to 51200 steps/rev in increments of 2 steps/rev
Encoder Resolution	20000 counts/rev
Speed Range	Up to 3600rpm
Filters	Digital input noise filter, Smoothing filter, PID filter, Notch filter
Non-Volatile Storage	Configurations are saved in FLASH memory on-board the DSP
Modes of Operation	Step & Direction, CW/CCW pulse, A/B quadrature pulse
Digital Inputs	X1/STEP+/- : Optically isolated, 5-24 volt. Minimum pulse width = 250 ns, Maximum pulse frequency = 2 MHz Function: Step, CW step, A quadrature (encoder following) X2/DIR+/- : Optically isolated, 5-24 volt. Minimum pulse width = 250 ns, Maximum pulse frequency = 2 MHz Function: Direction, CCW step, B quadrature (encoder following) X3/EN, X4/AR : Optically isolated, 5-24 volt. Function: Enable, Alarm Reset or general purpose input
Digital Outputs	Y1, Y2, Y3 : Optically isolated, 30V/100 mA max. Function: Fault, In position, Brake, Tach, Timing or general purpose programmable
Encoder output	Standard Line driver outputs including A+/A-/B+/B-/Z+/Z- are supported
Communication Interface	RS-232
Physical	
Ambient Temperature	0 to 40°C (32 to 104°F) When mounted to a suitable heatsink
Humidity	90% Max., non-condensing
Mass	TSM17P-1AG: 280 g TSM17P-2AG: 360 g TSM17P-3AG: 440 g
Rotor Inertia	TSM17P-1AG: 38g.cm ² TSM17P-2AG: 57g.cm ² TSM17P-3AG: 82g.cm ²

5.3 Torque-Speed Curves

Note: all torque curves were measured at 20,000 steps/rev.

Note: 2 amp rating is continuous, 3 amp rating is boost

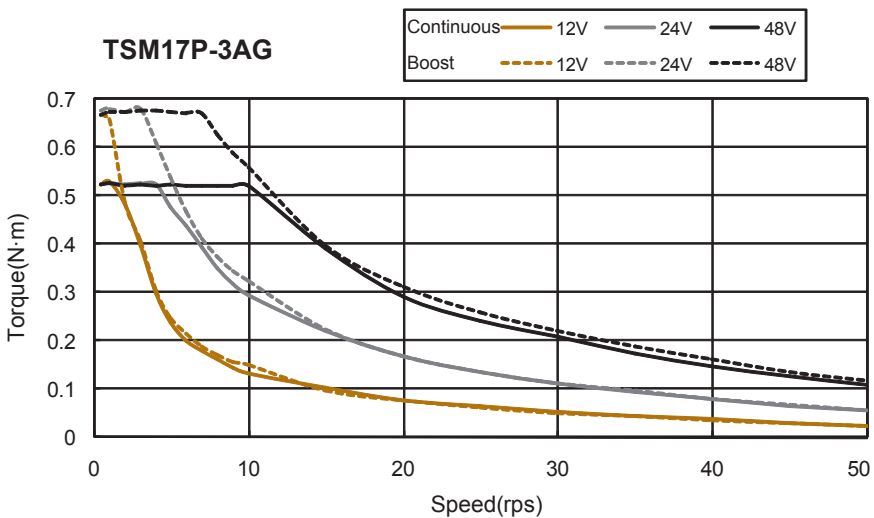
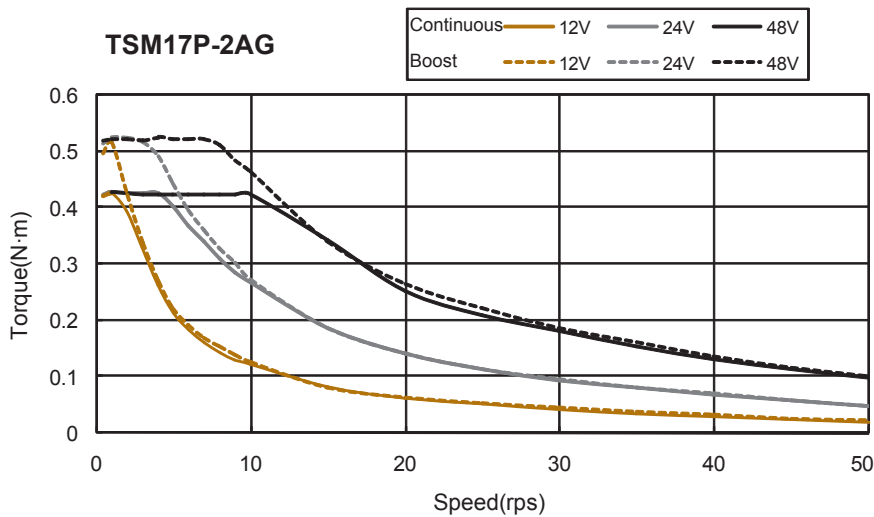
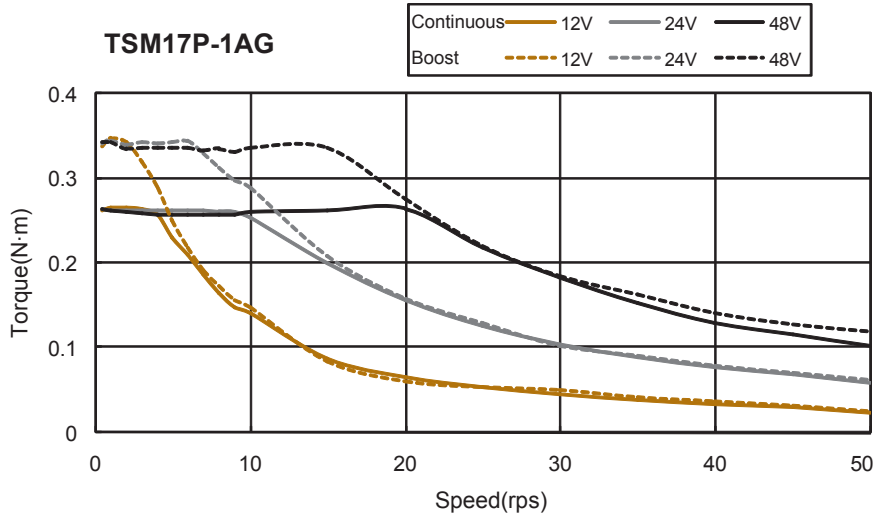

6 Contacting MOONS'



■ Headquarters

No. 168 Mingjia Road Industrial Park North Minhang District Shanghai 201107, P.R. China
Tel: +86(0)21-52634688
Fax: +86(0)21-62968682
E-mail: info@moons.com.cn

■ MOONS' Industries (America), Inc.

1113 North Prospect Avenue, Itasca, IL 60143 U.S.A.
Tel: 001-630-833-5940
Fax: 001-630-833-5946

■ MOONS' Industries (Europe) S.r.l.

Via Torri Bianche n.1 20059 Vimercate(MB) Italy
Tel: +39 039 62 60 521
Fax: +39 039 96 31 409

■ MOONS' Industries (South-East Asia) Pte Ltd.

33 Ubi Avenue 3 #08-23 Vertex Singapore 408868
Tel: +65 6634 1198
Fax: +65 6634 1138

■ Shenzhen Branch Office

Room 2209, 22/F, Kerry Center, No. 2008 Renminnan Road Shenzhen 518001 P. R.China
Tel: +86 (0)755 25472080
Fax: +86 (0)755 25472081

■ Beijing Branch Office

Room 202, Unit 2, 7th Building, Huilongsen International Science & Technology Industry Park,
No.99, Kechuang 14th Street, Beijing 101111 P. R.China
Tel: +86 (0)10 59755578
Fax: +86 (0)10 59755579

■ Qingdao Branch Office

Room 10E, No.73 Wangjiao Mansion, mid. Hongkong Road Qingdao 266071 P. R.China
Tel: +86 (0)532 85879625
Fax: +86 (0)532 85879512

■ Wuhan Branch Office

Room 3001, World Trade Tower, No.686 Jiefang Avenue, Jiangnan District, Wuhan 430022 P.R.China
Tel: +86 (0)27-85448742
Fax: +86 (0)27-85448355

■ Nanjing Branch Office

Room 302, Building A, Tengfei Creation Center, 55 Jiangjun Avenue, Jiangning District, Nanjing 211100 P. R.China
Tel: +86 (0)25 52785841
Fax: +86 (0)25 52785485

■ Chengdu Branch Office

Room 1917, Western Tower, No.19, 4th Section of South People Road, Wuhou District, Chengdu 610041
P.R.China
Tel: +86 (0)28-85268102
Fax: +86 (0)28-85268103

■ Xi'an Branch Office

Room 1006, Block D, Wangzuo International City, No.1 Tangyan Road, Xi'an 710065 P.R. China
Tel: +86 (0)29 81870400
Fax: +86 (0)29 81870340